

SYLLABUS:

Module – I

Data Mining overview, Data Warehouse and OLAP Technology, Data Warehouse Architecture, Steps for the Design and Construction of Data Warehouses, A Three-Tier Data Warehouse Architecture, OLAP, OLAP queries, metadata repository, Data Preprocessing – Data Integration and Transformation, Data Reduction, Data Mining Primitives: What Defines a Data Mining Task? Task-Relevant Data, The Kind of Knowledge to be Mined, KDD

Module – II

Mining Association Rules in Large Databases, Association Rule Mining, Market Basket Analysis: Mining A Road Map, The Apriori Algorithm: Finding Frequent Itemsets Using Candidate Generation, Generating Association Rules from Frequent Itemsets, Improving the Efficiency of Apriori, Mining Frequent Itemsets without Candidate Generation, Multilevel Association Rules, Approaches to Mining Multilevel Association Rules, Mining Multidimensional Association Rules for Relational Database and Data Warehouses, Multidimensional Association Rules, Mining Quantitative Association Rules, Mining Distance-Based Association Rules, From Association Mining to Correlation Analysis

Module – III

What is Classification? What Is Prediction? Issues Regarding Classification and Prediction, Classification by Decision Tree Induction, Bayesian Classification, Bayes Theorem, Naïve Bayesian Classification, Classification by Backpropagation, A Multilayer Feed-Forward Neural Network, Defining a Network Topology, Classification Based on Concepts from Association Rule Mining, Other Classification Methods, k-Nearest Neighbor Classifiers, Genetic Algorithms, Rough Set Approach, Fuzzy Set Approaches, Prediction, Linear and Multiple Regression, Nonlinear Regression, Other Regression Models, Classifier Accuracy

Module – IV

What Is Cluster Analysis, Types of Data in Cluster Analysis, A Categorization of Major Clustering Methods, Classical Partitioning Methods: k-Means and k-Medoids, Partitioning Methods in Large Databases: From k-Medoids to CLARANS, Hierarchical Methods, Agglomerative and Divisive Hierarchical Clustering, Density-Based Methods, Wave Cluster: Clustering Using Wavelet Transformation, CLIQUE: Clustering High-Dimensional Space, Model-Based Clustering Methods, Statistical Approach, Neural Network Approach.

Chapter-1

1.1 What Is Data Mining?

Data mining refers to extracting or mining knowledge from large amounts of data. The term is actually a misnomer. Thus, data mining should have been more appropriately named as knowledge mining which emphasizes on mining from large amounts of data.

It is the computational process of discovering patterns in large data sets involving methods at the intersection of artificial intelligence, machine learning, statistics, and database systems.

The overall goal of the data mining process is to extract information from a data set and transform it into an understandable structure for further use.

The key properties of data mining are

- Automatic discovery of patterns
- Prediction of likely outcomes
- Creation of actionable information
- Focus on large datasets and databases

1.2 The Scope of Data Mining

Data mining derives its name from the similarities between searching for valuable business information in a large database — for example, finding linked products in gigabytes of store scanner data — and mining a mountain for a vein of valuable ore. Both processes require either sifting through an immense amount of material, or intelligently probing it to find exactly where the value resides. Given databases of sufficient size and quality, data mining technology can generate new business opportunities by providing these capabilities:

Automated prediction of trends and behaviors. Data mining automates the process of finding predictive information in large databases. Questions that traditionally required extensive hands-on analysis can now be answered directly from the data — quickly. A typical example of a predictive problem is targeted marketing. Data mining uses data on past promotional mailings to identify the targets most likely to maximize return on investment in future mailings. Other predictive problems include forecasting bankruptcy and other forms of default, and identifying segments of a population likely to respond similarly to given events.

Automated discovery of previously unknown patterns. Data mining tools sweep through databases and identify previously hidden patterns in one step. An example of pattern discovery is the analysis of retail sales data to identify seemingly unrelated products that are often purchased together. Other pattern discovery problems include detecting fraudulent credit card transactions and identifying anomalous data that could represent data entry keying errors.

1.3 Tasks of Data Mining

Data mining involves six common classes of tasks:

- **Anomaly detection (Outlier/change/deviation detection)** – The identification of unusual data records, that might be interesting or data errors that require further investigation.
- **Association rule learning (Dependency modelling)** – Searches for relationships between variables. For example a supermarket might gather data on customer purchasing habits. Using association rule learning, the supermarket can determine which products are frequently bought together and use this information for marketing purposes. This is sometimes referred to as market basket analysis.
- **Clustering** – is the task of discovering groups and structures in the data that are in some way or another "similar", without using known structures in the data.
- **Classification** – is the task of generalizing known structure to apply to new data. For example, an e-mail program might attempt to classify an e-mail as "legitimate" or as "spam".
- **Regression** – attempts to find a function which models the data with the least error.

- **Summarization** – providing a more compact representation of the data set, including visualization and report generation.

1.4 Architecture of Data Mining

A typical data mining system may have the following major components.

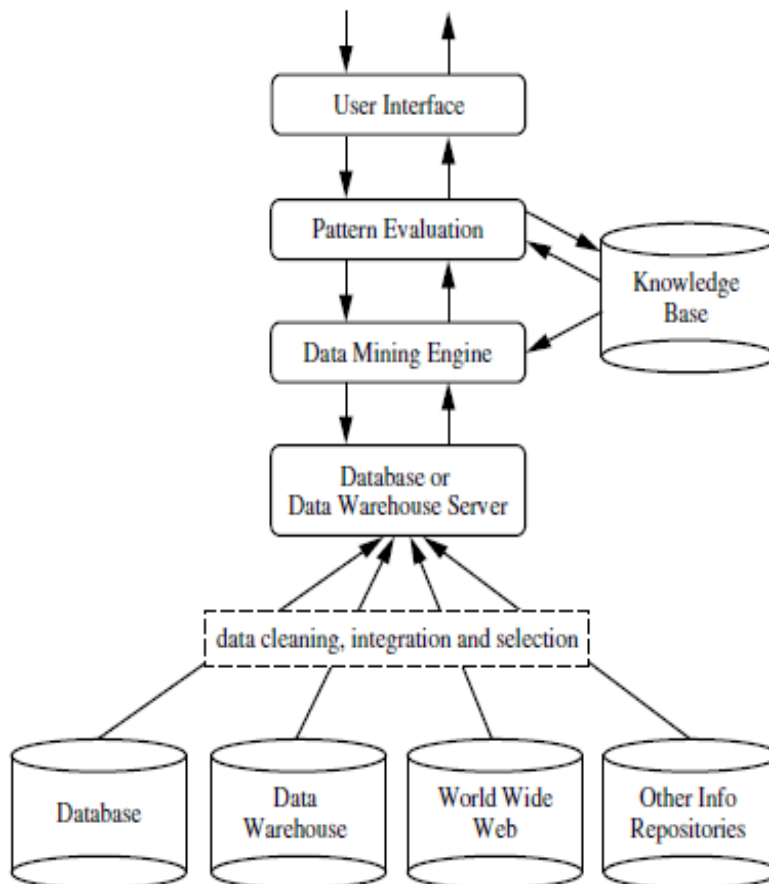

1. Knowledge Base:

This is the domain knowledge that is used to guide the search or evaluate the interestingness of resulting patterns. Such knowledge can include concept hierarchies,

used to organize attributes or attribute values into different levels of abstraction. Knowledge such as user beliefs, which can be used to assess a pattern's interestingness based on its unexpectedness, may also be included. Other examples of domain knowledge are additional interestingness constraints or thresholds, and metadata (e.g., describing data from multiple heterogeneous sources).

2. Data Mining Engine:

This is essential to the data mining system and ideally consists of a set of functional modules for tasks such as characterization, association and correlation analysis, classification, prediction, cluster analysis, outlier analysis, and evolution analysis.

3. Pattern Evaluation Module:

This component typically employs interestingness measures and interacts with the data mining modules so as to focus the search toward interesting patterns. It may use interestingness thresholds to filter out discovered patterns. Alternatively, the pattern evaluation module may be integrated with the mining module, depending on the implementation of the data mining method used. For efficient data mining, it is highly recommended to push the evaluation of pattern interestingness as deep as possible into the mining process so as to confine the search to only the interesting patterns.

4. User interface:

This module communicates between users and the data mining system, allowing the user to interact with the system by specifying a data mining query or task, providing information to help focus the search, and performing exploratory data mining based on the intermediate data mining results. In addition, this component allows the user to browse database and data warehouse schemas or data structures, evaluate mined patterns, and visualize the patterns in different forms.

1.5 Data Mining Process:

Data Mining is a process of discovering various models, summaries, and derived values from a given collection of data.

The general experimental procedure adapted to data-mining problems involves the following steps:

1. State the problem and formulate the hypothesis

Most data-based modeling studies are performed in a particular application domain. Hence, domain-specific knowledge and experience are usually necessary in order to come up with a meaningful problem statement. Unfortunately, many application studies tend to focus on the data-mining technique at the expense of a clear problem statement. In this step, a modeler usually specifies a set of variables for the unknown dependency and, if possible, a general form of this dependency as an initial hypothesis. There may be several hypotheses formulated for a single problem at this stage. The first step requires the combined expertise of an application domain and a data-mining model. In practice, it usually means a close interaction between the data-mining expert and the application expert. In successful data-mining applications, this cooperation does not stop in the initial phase; it continues during the entire data-mining process.

2. Collect the data

This step is concerned with how the data are generated and collected. In general, there are two distinct possibilities. The first is when the data-generation process is under the control of an expert (modeler): this approach is known as a designed experiment. The second possibility is when the expert cannot influence the data-generation process: this is known as the observational approach. An observational setting, namely, random data generation, is assumed in most data-mining applications. Typically, the sampling

distribution is completely unknown after data are collected, or it is partially and implicitly given in the data-collection procedure. It is very important, however, to understand how data collection affects its theoretical distribution, since such a priori knowledge can be very useful for modeling and, later, for the final interpretation of results. Also, it is important to make sure that the data used for estimating a model and the data used later for testing and applying a model come from the same, unknown, sampling distribution. If this is not the case, the estimated model cannot be successfully used in a final application of the results.

3. Preprocessing the data

In the observational setting, data are usually "collected" from the existing databases, data warehouses, and data marts. Data preprocessing usually includes at least two common tasks:

1. Outlier detection (and removal) – Outliers are unusual data values that are not consistent with most observations. Commonly, outliers result from measurement errors, coding and recording errors, and, sometimes, are natural, abnormal values. Such nonrepresentative samples can seriously affect the model produced later. There are two strategies for dealing with outliers:

- a. Detect and eventually remove outliers as a part of the preprocessing phase, or
- b. Develop robust modeling methods that are insensitive to outliers.

2. Scaling, encoding, and selecting features – Data preprocessing includes several steps such as variable scaling and different types of encoding. For example, one feature with the range $[0, 1]$ and the other with the range $[-100, 1000]$ will not have the same weights in the applied technique; they will also influence the final data-mining results differently. Therefore, it is recommended to scale them and bring both features to the same weight for further analysis. Also, application-specific encoding methods usually achieve

dimensionality reduction by providing a smaller number of informative features for subsequent data modeling.

These two classes of preprocessing tasks are only illustrative examples of a large spectrum of preprocessing activities in a data-mining process.

Data-preprocessing steps should not be considered completely independent from other data-mining phases. In every iteration of the data-mining process, all activities, together, could define new and improved data sets for subsequent iterations. Generally, a good preprocessing method provides an optimal representation for a data-mining technique by incorporating a priori knowledge in the form of application-specific scaling and encoding.

4. Estimate the model

The selection and implementation of the appropriate data-mining technique is the main task in this phase. This process is not straightforward; usually, in practice, the implementation is based on several models, and selecting the best one is an additional task. The basic principles of learning and discovery from data are given in Chapter 4 of this book. Later, Chapter 5 through 13 explain and analyze specific techniques that are applied to perform a successful learning process from data and to develop an appropriate model.

5. Interpret the model and draw conclusions

In most cases, data-mining models should help in decision making. Hence, such models need to be interpretable in order to be useful because humans are not likely to base their decisions on complex "black-box" models. Note that the goals of accuracy of the model and accuracy of its interpretation are somewhat contradictory. Usually, simple models are more interpretable, but they are also less accurate. Modern data-mining methods are expected to yield highly accurate results using highdimensional models. The problem of interpreting these models, also very important, is considered a separate task, with specific

techniques to validate the results. A user does not want hundreds of pages of numeric results. He does not understand them; he cannot summarize, interpret, and use them for successful decision making.

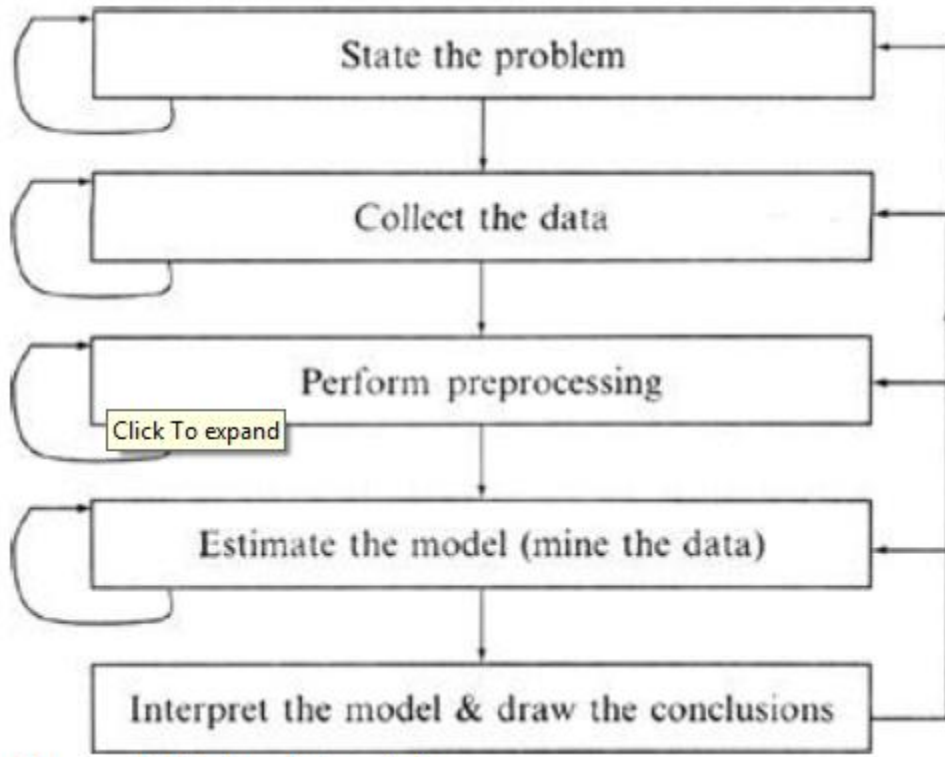

The Data mining Process

1.6 Classification of Data mining Systems:

The data mining system can be classified according to the following criteria:

- Database Technology
- Statistics
- Machine Learning
- Information Science
- Visualization
- Other Disciplines

Some Other Classification Criteria:

- Classification according to kind of databases mined
- Classification according to kind of knowledge mined
- Classification according to kinds of techniques utilized
- Classification according to applications adapted

Classification according to kind of databases mined

We can classify the data mining system according to kind of databases mined. Database system can be classified according to different criteria such as data models, types of data etc. And the data mining system can be classified accordingly. For example if we classify the database according to data model then we may have a relational, transactional, object- relational, or data warehouse mining system.

Classification according to kind of knowledge mined

We can classify the data mining system according to kind of knowledge mined. It means data mining system are classified on the basis of functionalities such as:

- Characterization
- Discrimination
- Association and Correlation Analysis
- Classification
- Prediction
- Clustering
- Outlier Analysis
- Evolution Analysis

Classification according to kinds of techniques utilized

We can classify the data mining system according to kind of techniques used. We can describe these techniques according to degree of user interaction involved or the methods of analysis employed.

Classification according to applications adapted

We can classify the data mining system according to application adapted. These applications are as follows:

- Finance
- Telecommunications
- DNA
- Stock Markets
- E-mail

1.7 Major Issues In Data Mining:

•**Mining different kinds of knowledge in databases.** - The need of different users is not the same. And Different user may be interested in different kind of knowledge. Therefore it is necessary for data mining to cover broad range of knowledge discovery task.

•**Interactive mining of knowledge at multiple levels of abstraction.** - The data mining process needs to be interactive because it allows users to focus the search for patterns, providing and refining data mining requests based on returned results.

•**Incorporation of background knowledge.** - To guide discovery process and to express the discovered patterns, the background knowledge can be used. Background knowledge may be used to express the discovered patterns not only in concise terms but at multiple level of abstraction.

•**Data mining query languages and ad hoc data mining.** - Data Mining Query language that allows the user to describe ad hoc mining tasks, should be integrated with a data warehouse query language and optimized for efficient and flexible data mining.

•**Presentation and visualization of data mining results.** - Once the patterns are discovered it needs to be expressed in high level languages, visual representations. This representations should be easily understandable by the users.

•**Handling noisy or incomplete data.** - The data cleaning methods are required that can handle the noise, incomplete objects while mining the data regularities. If data cleaning methods are not there then the accuracy of the discovered patterns will be poor.

•**Pattern evaluation.** - It refers to interestingness of the problem. The patterns discovered should be interesting because either they represent common knowledge or lack novelty.

• **Efficiency and scalability of data mining algorithms.** - In order to effectively extract the information from huge amount of data in databases, data mining algorithm must be efficient and scalable.

• **Parallel, distributed, and incremental mining algorithms.** - The factors such as huge size of databases, wide distribution of data, and complexity of data mining methods motivate the development of parallel and distributed data mining algorithms. These algorithm divide the data into partitions which is further processed parallel. Then the results from the partitions is merged. The incremental algorithms, updates databases without having mine the data again from scratch.

1.8 Knowledge Discovery in Databases(KDD)

Some people treat data mining same as Knowledge discovery while some people view data mining essential step in process of knowledge discovery. Here is the list of steps involved in knowledge discovery process:

- **Data Cleaning** - In this step the noise and inconsistent data is removed.
- **Data Integration** - In this step multiple data sources are combined.
- **Data Selection** - In this step relevant to the analysis task are retrieved from the database.
- **Data Transformation** - In this step data are transformed or consolidated into forms appropriate for mining by performing summary or aggregation operations.
- **Data Mining** - In this step intelligent methods are applied in order to extract data patterns.
- **Pattern Evaluation** - In this step, data patterns are evaluated.
- **Knowledge Presentation** - In this step,knowledge is represented.

The following diagram shows the process of knowledge discovery process:

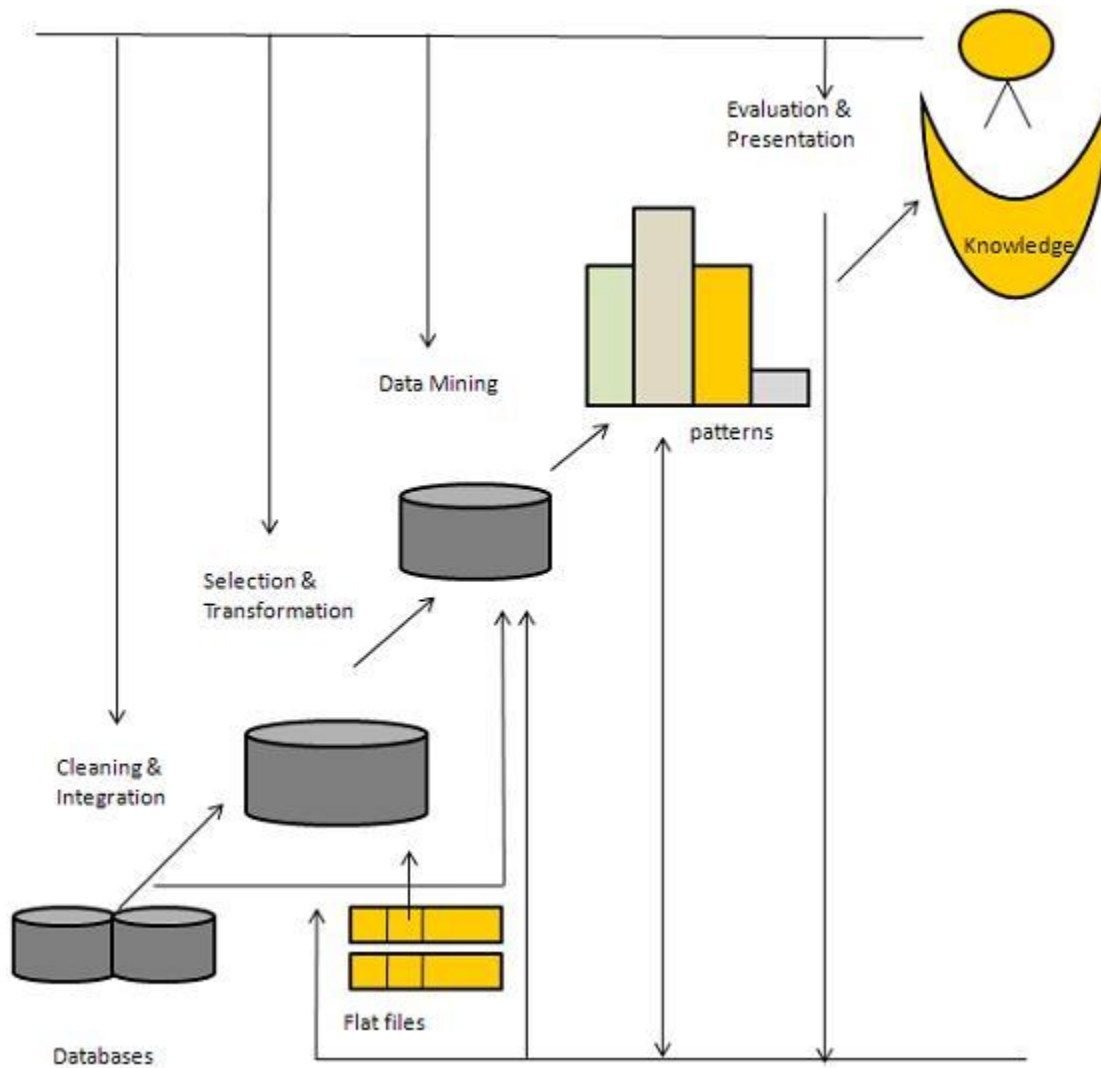

Architecture of KDD

1.9 Data Warehouse:

A data warehouse is a subject-oriented, integrated, time-variant and non-volatile collection of data in support of management's decision making process.

Subject-Oriented: A data warehouse can be used to analyze a particular subject area. For example, "sales" can be a particular subject.

Integrated: A data warehouse integrates data from multiple data sources. For example, source A and source B may have different ways of identifying a product, but in a data warehouse, there will be only a single way of identifying a product.

Time-Variant: Historical data is kept in a data warehouse. For example, one can retrieve data from 3 months, 6 months, 12 months, or even older data from a data warehouse. This contrasts with a transactions system, where often only the most recent data is kept. For example, a transaction system may hold the most recent address of a customer, where a data warehouse can hold all addresses associated with a customer.

Non-volatile: Once data is in the data warehouse, it will not change. So, historical data in a data warehouse should never be altered.

1.9.1 Data Warehouse Design Process:

A data warehouse can be built using a *top-down approach*, a *bottom-up approach*, or a *combination of both*.

- The top-down approach starts with the overall design and planning. It is useful in cases where the technology is mature and well known, and where the business problems that must be solved are clear and well understood.
- The bottom-up approach starts with experiments and prototypes. This is useful in the early stage of business modeling and technology development. It allows an organization to move forward at considerably less expense and to evaluate the benefits of the technology before making significant commitments.
- In the combined approach, an organization can exploit the planned and strategic nature of the top-down approach while retaining the rapid implementation and opportunistic application of the bottom-up approach.

The warehouse design process consists of the following steps:

- Choose a business process to model, for example, orders, invoices, shipments, inventory, account administration, sales, or the general ledger. If the business process is organizational and involves multiple complex object collections, a data warehouse model should be followed. However, if the process is departmental and focuses on the analysis of one kind of business process, a data mart model should be chosen.
- Choose the grain of the business process. The grain is the fundamental, atomic level of data to be represented in the fact table for this process, for example, individual transactions, individual daily snapshots, and so on.
- Choose the dimensions that will apply to each fact table record. Typical dimensions are time, item, customer, supplier, warehouse, transaction type, and status.
- Choose the measures that will populate each fact table record. Typical measures are numeric additive quantities like dollars sold and units sold.

1.9.2 A Three Tier Data Warehouse Architecture:

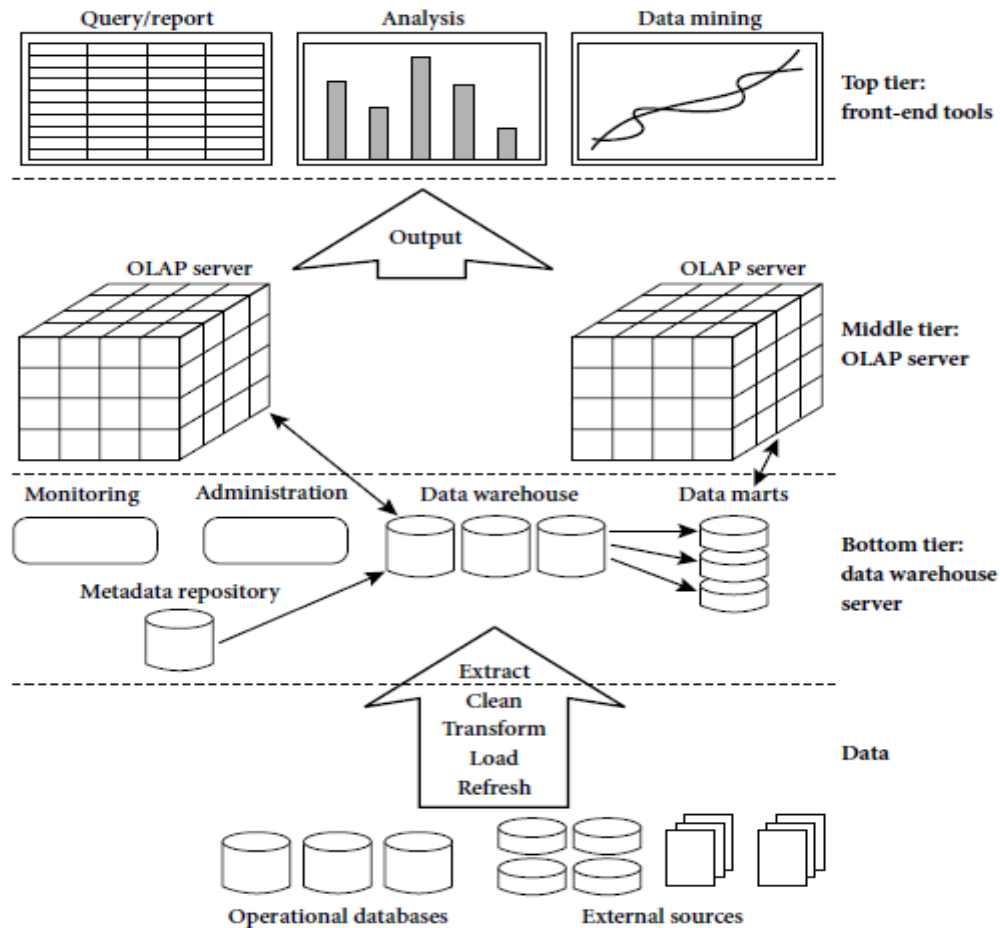

Tier-1:

The bottom tier is a warehouse database server that is almost always a relational database system. Back-end tools and utilities are used to feed data into the bottom tier from operational databases or other external sources (such as customer profile information provided by external consultants). These tools and utilities perform data extraction, cleaning, and transformation (e.g., to merge similar data from different sources into a unified format), as well as load and refresh functions to update the data warehouse. The data are extracted using application program interfaces known as gateways. A gateway is

supported by the underlying DBMS and allows client programs to generate SQL code to be executed at a server.

Examples of gateways include ODBC (Open Database Connection) and OLEDB (Open Linking and Embedding for Databases) by Microsoft and JDBC (Java Database Connection).

This tier also contains a metadata repository, which stores information about the data warehouse and its contents.

Tier-2:

The middle tier is an OLAP server that is typically implemented using either a relational OLAP (ROLAP) model or a multidimensional OLAP.

- OLAP model is an extended relational DBMS that maps operations on multidimensional data to standard relational operations.
- A multidimensional OLAP (MOLAP) model, that is, a special-purpose server that directly implements multidimensional data and operations.

Tier-3:

The top tier is a front-end client layer, which contains query and reporting tools, analysis tools, and/or data mining tools (e.g., trend analysis, prediction, and so on).

1.9.3 Data Warehouse Models:

There are three data warehouse models.

1. Enterprise warehouse:

- An enterprise warehouse collects all of the information about subjects spanning the entire organization.
- It provides corporate-wide data integration, usually from one or more operational systems or external information providers, and is cross-functional in scope.
- It typically contains detailed data as well as summarized data, and can range in size from a few gigabytes to hundreds of gigabytes, terabytes, or beyond.
- An enterprise data warehouse may be implemented on traditional mainframes, computer superservers, or parallel architecture platforms. It requires extensive business modeling and may take years to design and build.

2. Data mart:

- A data mart contains a subset of corporate-wide data that is of value to a specific group of users. The scope is confined to specific selected subjects. For example, a marketing data mart may confine its subjects to customer, item, and sales. The data contained in data marts tend to be summarized.
- Data marts are usually implemented on low-cost departmental servers that are UNIX/LINUX- or Windows-based. The implementation cycle of a data mart is more likely to be measured in weeks rather than months or years. However, it may involve complex integration in the long run if its design and planning were not enterprise-wide.

- Depending on the source of data, data marts can be categorized as independent or dependent. Independent data marts are sourced from data captured from one or more operational systems or external information providers, or from data generated locally within a particular department or geographic area. Dependent data marts are sourced directly from enterprise data warehouses.

3. Virtual warehouse:

- A virtual warehouse is a set of views over operational databases. For efficient query processing, only some of the possible summary views may be materialized.
- A virtual warehouse is easy to build but requires excess capacity on operational database servers.

1.9.4 Meta Data Repository:

Metadata are data about data. When used in a data warehouse, metadata are the data that define warehouse objects. Metadata are created for the data names and definitions of the given warehouse. Additional metadata are created and captured for timestamping any extracted data, the source of the extracted data, and missing fields that have been added by data cleaning or integration processes.

A metadata repository should contain the following:

- A description of the structure of the data warehouse, which includes the warehouse schema, view, dimensions, hierarchies, and derived data definitions, as well as data mart locations and contents.
- Operational metadata, which include data lineage (history of migrated data and the sequence of transformations applied to it), currency of data (active, archived, or purged), and monitoring information (warehouse usage statistics, error reports, and audit trails).

- The algorithms used for summarization, which include measure and dimension definitional algorithms, data on granularity, partitions, subject areas, aggregation, summarization, and predefined queries and reports.
- The mapping from the operational environment to the data warehouse, which includes source databases and their contents, gateway descriptions, data partitions, data extraction, cleaning, transformation rules and defaults, data refresh and purging rules, and security (user authorization and access control).
- Data related to system performance, which include indices and profiles that improve data access and retrieval performance, in addition to rules for the timing and scheduling of refresh, update, and replication cycles.
- Business metadata, which include business terms and definitions, data ownership information, and charging policies.

1.10 OLAP(Online analytical Processing):

- OLAP is an approach to answering multi-dimensional analytical (MDA) queries swiftly.
- OLAP is part of the broader category of business intelligence, which also encompasses relational database, report writing and data mining.
- OLAP tools enable users to analyze multidimensional data interactively from multiple perspectives.

OLAP consists of three basic analytical operations:

- Consolidation (Roll-Up)
- Drill-Down

➤ Slicing And Dicing

- Consolidation involves the aggregation of data that can be accumulated and computed in one or more dimensions. For example, all sales offices are rolled up to the sales department or sales division to anticipate sales trends.
- The drill-down is a technique that allows users to navigate through the details. For instance, users can view the sales by individual products that make up a region's sales.
- Slicing and dicing is a feature whereby users can take out (slicing) a specific set of data of the OLAP cube and view (dicing) the slices from different viewpoints.

1.10.1 Types of OLAP:

1. Relational OLAP (ROLAP):

- ROLAP works directly with relational databases. The base data and the dimension tables are stored as relational tables and new tables are created to hold the aggregated information. It depends on a specialized schema design.
- This methodology relies on manipulating the data stored in the relational database to give the appearance of traditional OLAP's slicing and dicing functionality. In essence, each action of slicing and dicing is equivalent to adding a "WHERE" clause in the SQL statement.
- ROLAP tools do not use pre-calculated data cubes but instead pose the query to the standard relational database and its tables in order to bring back the data required to answer the question.
- ROLAP tools feature the ability to ask any question because the methodology does not limit to the contents of a cube. ROLAP also has the ability to drill down to the lowest level of detail in the database.

2. Multidimensional OLAP (MOLAP):

- MOLAP is the 'classic' form of OLAP and is sometimes referred to as just OLAP.
- MOLAP stores this data in an optimized multi-dimensional array storage, rather than in a relational database. Therefore it requires the pre-computation and storage of information in the cube - the operation known as processing.
- MOLAP tools generally utilize a pre-calculated data set referred to as a data cube. The data cube contains all the possible answers to a given range of questions.
- MOLAP tools have a very fast response time and the ability to quickly write back data into the data set.

3. Hybrid OLAP (HOLAP):

- There is no clear agreement across the industry as to what constitutes Hybrid OLAP, except that a database will divide data between relational and specialized storage.
- For example, for some vendors, a HOLAP database will use relational tables to hold the larger quantities of detailed data, and use specialized storage for at least some aspects of the smaller quantities of more-aggregate or less-detailed data.
- HOLAP addresses the shortcomings of MOLAP and ROLAP by combining the capabilities of both approaches.
- HOLAP tools can utilize both pre-calculated cubes and relational data sources.

1.11 Data Preprocessing:

1.11.1 Data Integration:

It combines data from multiple sources into a coherent data store, as in data warehousing. These sources may include multiple databases, data cubes, or flat files.

The data integration systems are formally defined as triple $\langle G, S, M \rangle$

Where G: The global schema

S: Heterogeneous source of schemas

M: Mapping between the queries of source and global schema

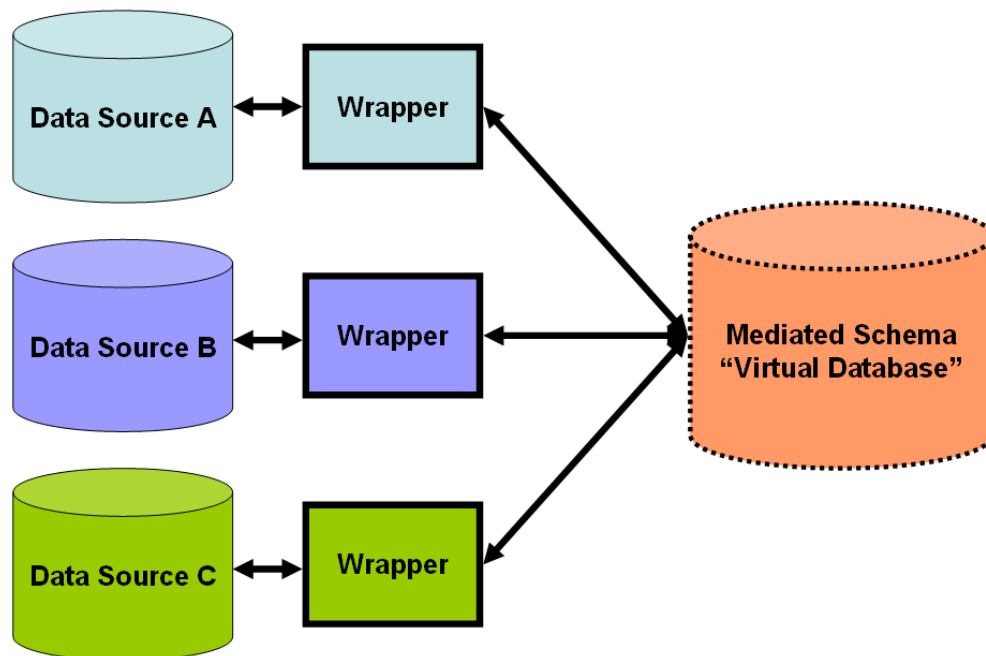

1.11.2 Issues in Data integration:

1. Schema integration and object matching:

How can the data analyst or the computer be sure that customer id in one database and customer number in another reference to the same attribute.

2. Redundancy:

An attribute (such as annual revenue, for instance) may be redundant if it can be derived from another attribute or set of attributes. Inconsistencies in attribute or dimension naming can also cause redundancies in the resulting data set.

3. detection and resolution of data value conflicts:

For the same real-world entity, attribute values from different sources may differ.

1.11.3 Data Transformation:

In data transformation, the data are transformed or consolidated into forms appropriate for mining.

Data transformation can involve the following:

- **Smoothing**, which works to remove noise from the data. Such techniques include binning, regression, and clustering.
- **Aggregation**, where summary or aggregation operations are applied to the data. For example, the daily sales data may be aggregated so as to compute monthly and annual total amounts. This step is typically used in constructing a data cube for analysis of the data at multiple granularities.

- **Generalization of the data**, where low-level or “primitive” (raw) data are replaced by higher-level concepts through the use of concept hierarchies. For example, categorical attributes, like street, can be generalized to higher-level concepts, like city or country.
- **Normalization**, where the attribute data are scaled so as to fall within a small specified range, such as 1:0 to 1:0, or 0:0 to 1:0.
- **Attribute construction** (or feature construction), where new attributes are constructed and added from the given set of attributes to help the mining process.

1.11.4 Data Reduction:

Data reduction techniques can be applied to obtain a reduced representation of the data set that is much smaller in volume, yet closely maintains the integrity of the original data. That is, mining on the reduced data set should be more efficient yet produce the same (or almost the same) analytical results.

Strategies for data reduction include the following:

- **Data cube aggregation**, where aggregation operations are applied to the data in the construction of a data cube.
- **Attribute subset selection**, where irrelevant, weakly relevant, or redundant attributes or dimensions may be detected and removed.
- **Dimensionality reduction**, where encoding mechanisms are used to reduce the dataset size.
- **Numerosity reduction**, where the data are replaced or estimated by alternative, smaller data representations such as parametric models (which need store only the model parameters instead of the actual data) or nonparametric methods such as clustering, sampling, and the use of histograms.
- **Discretization and concept hierarchy generation**, where raw data values for attributes are replaced by ranges or higher conceptual levels. Data discretization is a form of numerosity reduction that is very useful for the automatic generation of concept hierarchies. Discretization and concept hierarchy generation are powerful tools for data mining, in that they allow the mining of data at multiple levels of abstraction.

Chapter-2

2.1 Association Rule Mining:

- Association rule mining is a popular and well researched method for discovering interesting relations between variables in large databases.
- It is intended to identify strong rules discovered in databases using different measures of interestingness.
- Based on the concept of strong rules, Rakesh Agrawal et al. introduced association rules.

Problem Definition:

The problem of association rule mining is defined as:

Let $I = \{i_1, i_2, \dots, i_n\}$ be a set of n binary attributes called *items*.

Let $D = \{t_1, t_2, \dots, t_m\}$ be a set of transactions called the *database*.

Each transaction in D has a unique transaction ID and contains a subset of the items in I .

A *rule* is defined as an implication of the form $X \Rightarrow Y$

where $X, Y \subseteq I$ and $X \cap Y = \emptyset$.

The sets of items (for short *itemsets*) X and Y are called *antecedent* (left-hand-side or LHS) and *consequent* (right-hand-side or RHS) of the rule respectively.

Example:

To illustrate the concepts, we use a small example from the supermarket domain. The set of items is $I = \{\text{milk, bread, butter, beer}\}$ and a small database containing the items (1 codes presence and 0 absence of an item in a transaction) is shown in the table.

An example rule for the supermarket could be $\{\text{butter, bread}\} \Rightarrow \{\text{milk}\}$ meaning that if butter and bread are bought, customers also buy milk.

Example database with 4 items and 5 transactions

Transaction ID	milk	bread	butter	beer
1	1	1	0	0
2	0	0	1	0
3	0	0	0	1
4	1	1	1	0
5	0	1	0	0

2.1.1 Important concepts of Association Rule Mining:

- The **support** $\text{supp}(X)$ of an itemset X is defined as the proportion of transactions in the data set which contain the itemset. In the example database, the itemset $\{\text{milk, bread, butter}\}$ has a support of $1/5 = 0.2$ since it occurs in 20% of all transactions (1 out of 5 transactions).
- The **confidence** of a rule is defined

$$\text{conf}(X \Rightarrow Y) = \text{supp}(X \cup Y) / \text{supp}(X).$$

For example, the rule $\{\text{butter, bread}\} \Rightarrow \{\text{milk}\}$ has a confidence of $0.2/0.2 = 1.0$ in the database, which means that for 100% of the transactions containing butter and bread the rule is correct (100% of the times a customer buys butter and bread, milk is bought as well). Confidence can be interpreted as an estimate of the probability $P(Y|X)$, the probability of finding the RHS of the rule in transactions under the condition that these transactions also contain the LHS.

- The **lift** of a rule is defined as

$$\text{lift}(X \Rightarrow Y) = \frac{\text{supp}(X \cup Y)}{\text{supp}(X) \times \text{supp}(Y)}$$

or the ratio of the observed support to that expected if X and Y were independent. The

$$\text{rule } \{\text{milk, bread}\} \Rightarrow \{\text{butter}\} \text{ has a lift of } \frac{0.2}{0.4 \times 0.4} = 1.25.$$

- The **conviction** of a rule is defined as

$$\text{conv}(X \Rightarrow Y) = \frac{1 - \text{supp}(Y)}{1 - \text{conf}(X \Rightarrow Y)}.$$

$$\text{The rule } \{\text{milk, bread}\} \Rightarrow \{\text{butter}\} \text{ has a conviction of } \frac{1 - 0.4}{1 - .5} = 1.2,$$

and can be interpreted as the ratio of the expected frequency that X occurs without Y (that is to say, the frequency that the rule makes an incorrect prediction) if X and Y were independent divided by the observed frequency of incorrect predictions.

2.2 Market basket analysis:

This process analyzes customer buying habits by finding associations between the different items that customers place in their shopping baskets. The discovery of such associations can help retailers develop marketing strategies by gaining insight into which items are frequently purchased together by customers. For instance, if customers are buying milk, how likely are they to also buy bread (and what kind of bread) on the same trip to the supermarket. Such information can lead to increased sales by helping retailers do selective marketing and plan their shelf space.

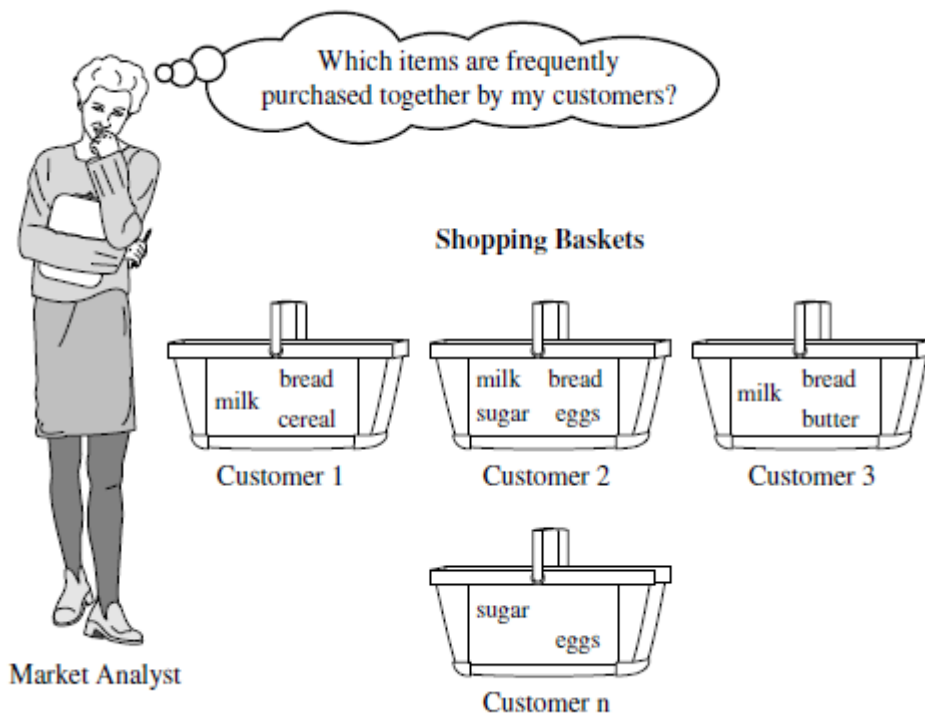

Example:

If customers who purchase computers also tend to buy antivirus software at the same time, then placing the hardware display close to the software display may help increase the sales of both items. In an alternative strategy, placing hardware and software at opposite ends of the store may entice customers who purchase such items to pick up other items along the way. For instance, after deciding on an expensive computer, a customer may observe security systems for sale while heading toward the software display to purchase antivirus software and may decide to purchase a home security system as well. Market basket analysis can also help retailers plan which items to put on sale at reduced prices. If customers tend to purchase computers and printers together, then having a sale on printers may encourage the sale of printers *as well as* computers.

2.3 Frequent Pattern Mining:

Frequent pattern mining can be classified in various ways, based on the following criteria:

1. Based on the completeness of patterns to be mined:

- We can mine the complete set of frequent itemsets, the closed frequent itemsets, and the maximal frequent itemsets, given a minimum support threshold.
- We can also mine constrained frequent itemsets, approximate frequent itemsets, near-match frequent itemsets, top-k frequent itemsets and so on.

2. Based on the levels of abstraction involved in the rule set:

Some methods for association rule mining can find rules at differing levels of abstraction.

For example, suppose that a set of association rules mined includes the following rules where X is a variable representing a customer:

$$\text{buys}(X, \text{"computer"}) \Rightarrow \text{buys}(X, \text{"HP printer"}) \quad (1)$$

$$\text{buys}(X, \text{"laptop computer"}) \Rightarrow \text{buys}(X, \text{"HP printer"}) \quad (2)$$

In rule (1) and (2), the items bought are referenced at different levels of abstraction (e.g., "computer" is a higher-level abstraction of "laptop computer").

3. Based on the number of data dimensions involved in the rule:

- If the items or attributes in an association rule reference only one dimension, then it is a single-dimensional association rule.

$$\text{buys}(X, \text{"computer"}) \Rightarrow \text{buys}(X, \text{"antivirus software"})$$

- If a rule references two or more dimensions, such as the dimensions age, income, and buys, then it is a multidimensional association rule. The following rule is an example of a multidimensional rule:

$$\text{age}(X, \text{"30,31...39"}) \wedge \text{income}(X, \text{"42K,...48K"}) \Rightarrow \text{buys}(X, \text{"high resolution TV"})$$

4. Based on the types of values handled in the rule:

- If a rule involves associations between the presence or absence of items, it is a Boolean association rule.
- If a rule describes associations between quantitative items or attributes, then it is a quantitative association rule.

5. Based on the kinds of rules to be mined:

- Frequent pattern analysis can generate various kinds of rules and other interesting relationships.
- Association rule mining can generate a large number of rules, many of which are redundant or do not indicate a correlation relationship among itemsets.
- The discovered associations can be further analyzed to uncover statistical correlations, leading to correlation rules.

6. Based on the kinds of patterns to be mined:

- Many kinds of frequent patterns can be mined from different kinds of data sets.
- Sequential pattern mining searches for frequent subsequences in a sequence data set, where a sequence records an ordering of events.
- For example, with sequential pattern mining, we can study the order in which items are frequently purchased. For instance, customers may tend to first buy a PC, followed by a digital camera, and then a memory card.
- Structured pattern mining searches for frequent substructures in a structured data set.
- Single items are the simplest form of structure.
- Each element of an itemset may contain a subsequence, a subtree, and so on.
- Therefore, structured pattern mining can be considered as the most general form of frequent pattern mining.

2.4 Efficient Frequent Itemset Mining Methods:

2.4.1 Finding Frequent Itemsets Using Candidate Generation: The Apriori Algorithm

- Apriori is a seminal algorithm proposed by R. Agrawal and R. Srikant in 1994 for mining frequent itemsets for Boolean association rules.
- The name of the algorithm is based on the fact that the algorithm uses *prior knowledge* of frequent itemset properties.
- Apriori employs an iterative approach known as a *level-wise* search, where k -itemsets are used to explore $(k+1)$ -itemsets.
- First, the set of frequent 1-itemsets is found by scanning the database to accumulate the count for each item, and collecting those items that satisfy minimum support. The resulting set is denoted L_1 . Next, L_1 is used to find L_2 , the set of frequent 2-itemsets, which is used to find L_3 , and so on, until no more frequent k -itemsets can be found.
- The finding of each L_k requires one full scan of the database.
- A two-step process is followed in Apriori consisting of join and prune action.

Algorithm: Apriori. Find frequent itemsets using an iterative level-wise approach based on candidate generation.

Input:

- D , a database of transactions;
- min_sup , the minimum support count threshold.

Output: L , frequent itemsets in D .

Method:

```

(1)  $L_1 = \text{find\_frequent\_1-itemsets}(D)$ ;
(2) for  $(k = 2; L_{k-1} \neq \phi; k++)$  {
(3)    $C_k = \text{apriori\_gen}(L_{k-1})$ ;
(4)   for each transaction  $t \in D$  { // scan  $D$  for counts
(5)      $C_t = \text{subset}(C_k, t)$ ; // get the subsets of  $t$  that are candidates
(6)     for each candidate  $c \in C_t$ 
(7)        $c.\text{count}++$ ;
(8)   }
(9)    $L_k = \{c \in C_k | c.\text{count} \geq min\_sup\}$ 
(10) }
(11) return  $L = \cup_k L_k$ ;

procedure apriori_gen( $L_{k-1}$ :frequent  $(k - 1)$ -itemsets)
(1) for each itemset  $I_1 \in L_{k-1}$ 
(2)   for each itemset  $I_2 \in L_{k-1}$ 
(3)     if  $(I_1[1] = I_2[1]) \wedge (I_1[2] = I_2[2]) \wedge \dots \wedge (I_1[k-2] = I_2[k-2]) \wedge (I_1[k-1] < I_2[k-1])$  then {
(4)        $c = I_1 \bowtie I_2$ ; // join step: generate candidates
(5)       if has_infrequent_subset( $c, L_{k-1}$ ) then
(6)         delete  $c$ ; // prune step: remove unfruitful candidate
(7)       else add  $c$  to  $C_k$ ;
(8)     }
(9) return  $C_k$ ;

procedure has_infrequent_subset( $c$ : candidate  $k$ -itemset;
                                 $L_{k-1}$ : frequent  $(k - 1)$ -itemsets); // use prior knowledge
(1) for each  $(k - 1)$ -subset  $s$  of  $c$ 
(2)   if  $s \notin L_{k-1}$  then
(3)     return TRUE;
(4) return FALSE;

```

Example:

TID	List of item IDs
T100	I1, I2, I5
T200	I2, I4
T300	I2, I3
T400	I1, I2, I4
T500	I1, I3
T600	I2, I3
T700	I1, I3
T800	I1, I2, I3, I5
T900	I1, I2, I3

There are nine transactions in this database, that is, $|D| = 9$.

Steps:

1. In the first iteration of the algorithm, each item is a member of the set of candidate 1-itemsets, C_1 . The algorithm simply scans all of the transactions in order to count the number of occurrences of each item.
2. Suppose that the minimum support count required is 2, that is, $\min \text{sup} = 2$. The set of frequent 1-itemsets, L_1 , can then be determined. It consists of the candidate 1-itemsets satisfying minimum support. In our example, all of the candidates in C_1 satisfy minimum support.
3. To discover the set of frequent 2-itemsets, L_2 , the algorithm uses the join L_1 on L_1 to generate a candidate set of 2-itemsets, C_2 . No candidates are removed from C_2 during the prune step because each subset of the candidates is also frequent.
4. Next, the transactions in D are scanned and the support count of each candidate itemset in C_2 is accumulated.
5. The set of frequent 2-itemsets, L_2 , is then determined, consisting of those candidate 2-itemsets in C_2 having minimum support.
6. The generation of the set of candidate 3-itemsets, C_3 , From the join step, we first get $C_3 = L_2 \times L_2 = (\{I_1, I_2, I_3\}, \{I_1, I_2, I_5\}, \{I_1, I_3, I_5\}, \{I_2, I_3, I_4\}, \{I_2, I_3, I_5\}, \{I_2, I_4, I_5\})$. Based on the Apriori property that all subsets of a frequent itemset must also be frequent, we can determine that the four latter candidates cannot possibly be frequent.
7. The transactions in D are scanned in order to determine L_3 , consisting of those candidate 3-itemsets in C_3 having minimum support.
8. The algorithm uses $L_3 \times L_3$ to generate a candidate set of 4-itemsets, C_4 .

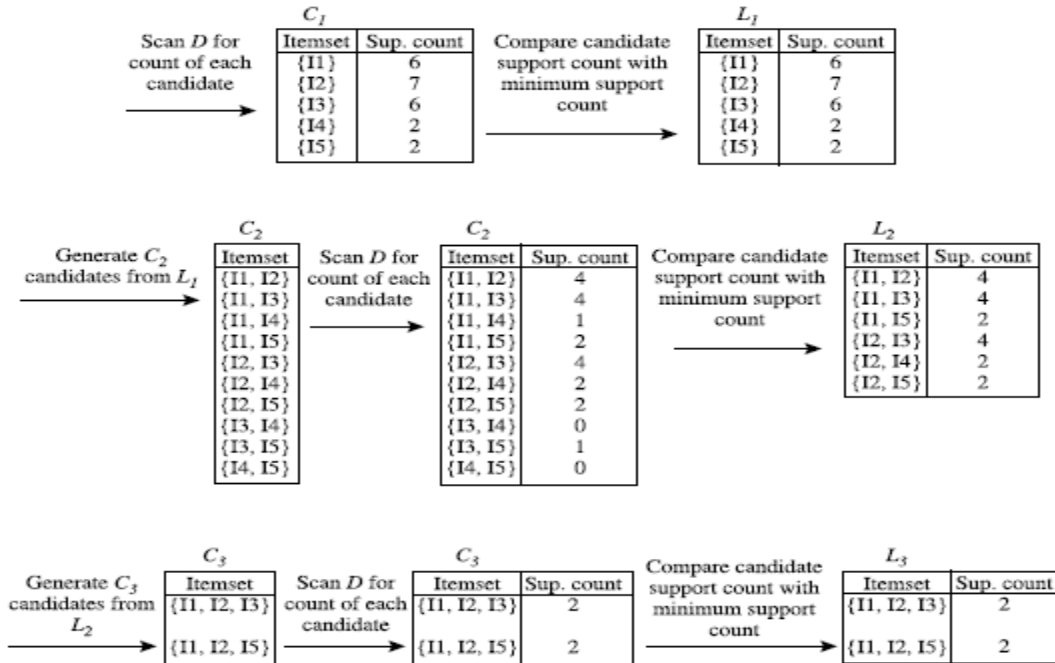

Generation of candidate itemsets and frequent itemsets, where the minimum support count is 2.

- (a) Join: $C_3 = L_2 \bowtie L_2 = \{\{I1, I2\}, \{I1, I3\}, \{I1, I5\}, \{I2, I3\}, \{I2, I4\}, \{I2, I5\}\} \bowtie \{\{I1, I2\}, \{I1, I3\}, \{I1, I5\}, \{I2, I3\}, \{I2, I4\}, \{I2, I5\}\}$
 $= \{\{I1, I2, I3\}, \{I1, I2, I5\}, \{I1, I3, I5\}, \{I2, I3, I4\}, \{I2, I3, I5\}, \{I2, I4, I5\}\}.$
- (b) Prune using the Apriori property: All nonempty subsets of a frequent itemset must also be frequent. Do any of the candidates have a subset that is not frequent?
- The 2-item subsets of {I1, I2, I3} are {I1, I2}, {I1, I3}, and {I2, I3}. All 2-item subsets of {I1, I2, I3} are members of L_2 . Therefore, keep {I1, I2, I3} in C_3 .
 - The 2-item subsets of {I1, I2, I5} are {I1, I2}, {I1, I5}, and {I2, I5}. All 2-item subsets of {I1, I2, I5} are members of L_2 . Therefore, keep {I1, I2, I5} in C_3 .
 - The 2-item subsets of {I1, I3, I5} are {I1, I3}, {I1, I5}, and {I3, I5}. {I3, I5} is not a member of L_2 , and so it is not frequent. Therefore, remove {I1, I3, I5} from C_3 .
 - The 2-item subsets of {I2, I3, I4} are {I2, I3}, {I2, I4}, and {I3, I4}. {I3, I4} is not a member of L_2 , and so it is not frequent. Therefore, remove {I2, I3, I4} from C_3 .
 - The 2-item subsets of {I2, I3, I5} are {I2, I3}, {I2, I5}, and {I3, I5}. {I3, I5} is not a member of L_2 , and so it is not frequent. Therefore, remove {I2, I3, I5} from C_3 .
 - The 2-item subsets of {I2, I4, I5} are {I2, I4}, {I2, I5}, and {I4, I5}. {I4, I5} is not a member of L_2 , and so it is not frequent. Therefore, remove {I2, I4, I5} from C_3 .
- (c) Therefore, $C_3 = \{\{I1, I2, I3\}, \{I1, I2, I5\}\}$ after pruning.

Generation and pruning of candidate 3-itemsets, C_3 , from L_2 using the Apriori property.

2.4.2 Generating Association Rules from Frequent Itemsets:

Once the frequent itemsets from transactions in a database D have been found, it is straightforward to generate strong association rules from them.

$$\text{confidence}(A \Rightarrow B) = P(B|A) = \frac{\text{support_count}(A \cup B)}{\text{support_count}(A)}.$$

The conditional probability is expressed in terms of itemset support count, where $\text{support_count}(A \cup B)$ is the number of transactions containing the itemsets $A \cup B$, and $\text{support_count}(A)$ is the number of transactions containing the itemset A . Based on this equation, association rules can be generated as follows:

- For each frequent itemset l , generate all nonempty subsets of l .
- For every nonempty subset s of l , output the rule " $s \Rightarrow (l - s)$ " if $\frac{\text{support_count}(l)}{\text{support_count}(s)} \geq \text{min_conf}$, where min_conf is the minimum confidence threshold.

Example:

Generating association rules. Let's try an example based on the transactional data for *AllElectronics* shown in Table 5.1. Suppose the data contain the frequent itemset $l = \{I1, I2, I5\}$. What are the association rules that can be generated from l ? The nonempty subsets of l are $\{I1, I2\}$, $\{I1, I5\}$, $\{I2, I5\}$, $\{I1\}$, $\{I2\}$, and $\{I5\}$. The resulting association rules are as shown below, each listed with its confidence:

$I1 \wedge I2 \Rightarrow I5,$	$\text{confidence} = 2/4 = 50\%$
$I1 \wedge I5 \Rightarrow I2,$	$\text{confidence} = 2/2 = 100\%$
$I2 \wedge I5 \Rightarrow I1,$	$\text{confidence} = 2/2 = 100\%$
$I1 \Rightarrow I2 \wedge I5,$	$\text{confidence} = 2/6 = 33\%$
$I2 \Rightarrow I1 \wedge I5,$	$\text{confidence} = 2/7 = 29\%$
$I5 \Rightarrow I1 \wedge I2,$	$\text{confidence} = 2/2 = 100\%$

2.5 Mining Multilevel Association Rules:

- For many applications, it is difficult to find strong associations among data items at low or primitive levels of abstraction due to the sparsity of data at those levels.
- Strong associations discovered at high levels of abstraction may represent commonsense knowledge.
- Therefore, data mining systems should provide capabilities for mining association rules at multiple levels of abstraction, with sufficient flexibility for easy traversal among different abstraction spaces.

- Association rules generated from mining data at multiple levels of abstraction are called multiple-level or multilevel association rules.
- Multilevel association rules can be mined efficiently using concept hierarchies under a support-confidence framework.
- In general, a top-down strategy is employed, where counts are accumulated for the calculation of frequent itemsets at each concept level, starting at the concept level 1 and working downward in the hierarchy toward the more specific concept levels, until no more frequent itemsets can be found.

A concept hierarchy defines a sequence of mappings from a set of low-level concepts to higher-level, more general concepts. Data can be generalized by replacing low-level concepts within the data by their higher-level concepts, or ancestors, from a concept hierarchy.

<i>TID</i>	<i>Items Purchased</i>
T100	IBM-ThinkPad-T40/2373, HP-Photosmart-7660
T200	Microsoft-Office-Professional-2003, Microsoft-Plus!-Digital-Media
T300	Logitech-MX700-Cordless-Mouse, Fellowes-Wrist-Rest
T400	Dell-Dimension-XPS, Canon-PowerShot-S400
T500	IBM-ThinkPad-R40/P4M, Symantec-Norton-Antivirus-2003
...	...

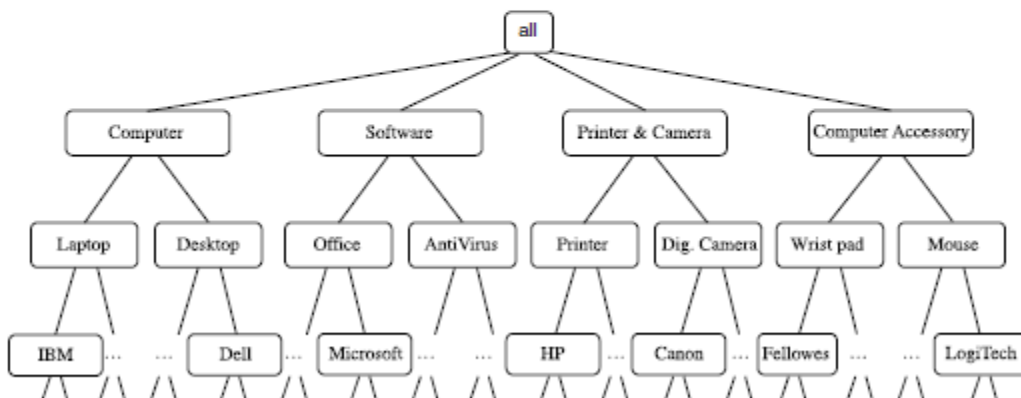

A concept hierarchy for AllElectronics computer items.

The concept hierarchy has five levels, respectively referred to as levels 0 to 4, starting with level 0 at the root node for all.

- Here, Level 1 includes computer, software, printer&camera, and computer accessory.
- Level 2 includes laptop computer, desktop computer, office software, antivirus software
- Level 3 includes IBM desktop computer, . . . , Microsoft office software, and so on.
- Level 4 is the most specific abstraction level of this hierarchy.

2.5.1 Approaches For Mining Multilevel Association Rules:

1. Uniform Minimum Support:

- The same minimum support threshold is used when mining at each level of abstraction.
- When a uniform minimum support threshold is used, the search procedure is simplified.
- The method is also simple in that users are required to specify only one minimum support threshold.
- The uniform support approach, however, has some difficulties. It is unlikely that items at lower levels of abstraction will occur as frequently as those at higher levels of abstraction.
- If the minimum support threshold is set too high, it could miss some meaningful associations occurring at low abstraction levels. If the threshold is set too low, it may generate many uninteresting associations occurring at high abstraction levels.

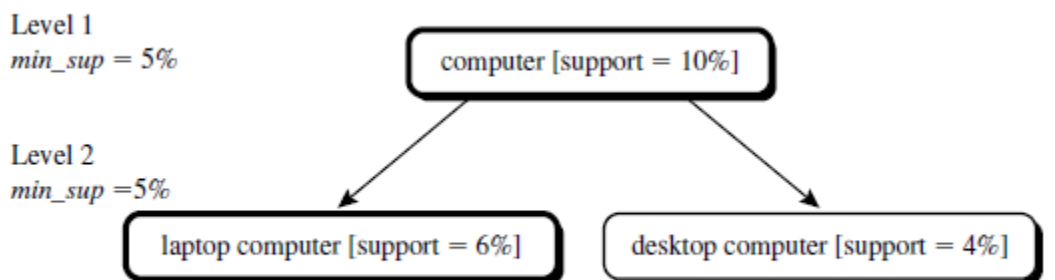

Multilevel mining with uniform support.

2. Reduced Minimum Support:

- Each level of abstraction has its own minimum support threshold.

- The deeper the level of abstraction, the smaller the corresponding threshold is.
- For example, the minimum support thresholds for levels 1 and 2 are 5% and 3%, respectively. In this way, “computer,” “laptop computer,” and “desktop computer” are all considered frequent.

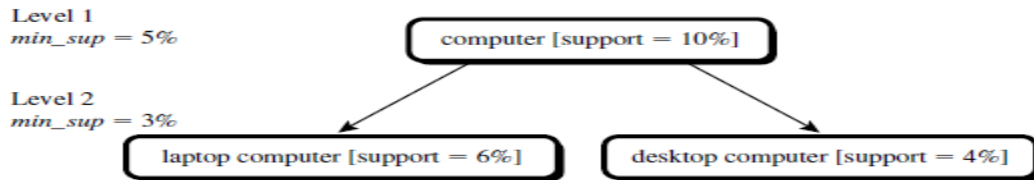

3. Group-Based Minimum Support:

- Because users or experts often have insight as to which groups are more important than others, it is sometimes more desirable to set up user-specific, item, or group based minimal support thresholds when mining multilevel rules.
- For example, a user could set up the minimum support thresholds based on product price, or on items of interest, such as by setting particularly low support thresholds for laptop computers and flash drives in order to pay particular attention to the association patterns containing items in these categories.

2.6 Mining Multidimensional Association Rules from Relational Databases and Data Warehouses:

- Single dimensional or intradimensional association rule contains a single distinct predicate (e.g., buys) with multiple occurrences i.e., the predicate occurs more than once within the rule.

buys(X, “digital camera”) => buys(X, “HP printer”)

- Association rules that involve two or more dimensions or predicates can be referred to as multidimensional association rules.

$age(X, "20...29") \wedge occupation(X, "student") \Rightarrow buys(X, "laptop")$

- Above Rule contains three predicates (age, occupation, and buys), each of which occurs only once in the rule. Hence, we say that it has no repeated predicates.
- Multidimensional association rules with no repeated predicates are called interdimensional association rules.
- We can also mine multidimensional association rules with repeated predicates, which contain multiple occurrences of some predicates. These rules are called hybrid-dimensional association rules. An example of such a rule is the following, where the predicate buys is repeated:

$age(X, "20...29") \wedge buys(X, "laptop") \Rightarrow buys(X, "HP printer")$

2.7 Mining Quantitative Association Rules:

- Quantitative association rules are multidimensional association rules in which the numeric attributes are *dynamically* discretized during the mining process so as to satisfy some mining criteria, such as maximizing the confidence or compactness of the rules mined.
- In this section, we focus specifically on how to mine quantitative association rules having two quantitative attributes on the left-hand side of the rule and one categorical attribute on the right-hand side of the rule. That is

$A_{quan1} \wedge A_{quan2} \Rightarrow A_{cat}$

where A_{quan1} and A_{quan2} are tests on quantitative attribute interval

A_{cat} tests a categorical attribute from the task-relevant data.

- Such rules have been referred to as two-dimensional quantitative association rules, because they contain two quantitative dimensions.
- For instance, suppose you are curious about the association relationship between pairs of quantitative attributes, like customer age and income, and the type of television (such as *high-definition TV*, i.e., *HDTV*) that customers like to buy.

An example of such a 2-D quantitative association rule is

$age(X, "30...39") \wedge income(X, "42K...48K") \Rightarrow buys(X, "HDTV")$

2.8 From Association Mining to Correlation Analysis:

- A correlation measure can be used to augment the support-confidence framework for association rules. This leads to *correlation rules* of the form $A \Rightarrow B$ [*support, confidence, correlation*]
- That is, a correlation rule is measured not only by its support and confidence but also by the correlation between itemsets A and B . There are many different correlation measures from which to choose. In this section, we study various correlation measures to determine which would be good for mining large data sets.
- Lift is a simple correlation measure that is given as follows. The occurrence of itemset A is independent of the occurrence of itemset B if $P(A \cup B) = P(A)P(B)$; otherwise, itemsets A and B are dependent and correlated as events. This definition can easily be extended to more than two itemsets.

The lift between the occurrence of A and B can be measured by computing

$$\text{lift}(A, B) = \frac{P(A \cup B)}{P(A)P(B)}.$$

- If the $\text{lift}(A, B)$ is less than 1, then the occurrence of A is negatively correlated with the occurrence of B .
- If the resulting value is greater than 1, then A and B are positively correlated, meaning that the occurrence of one implies the occurrence of the other.
- If the resulting value is equal to 1, then A and B are independent and there is no correlation between them.

Chapter-3

3.1 Classification and Prediction:

- Classification and prediction are two forms of data analysis that can be used to extract models describing important data classes or to predict future data trends.
- Classification predicts categorical (discrete, unordered) labels, *prediction* models continuous valued functions.
- For example, we can build a classification model to categorize bank loan applications as either safe or risky, or a prediction model to predict the expenditures of potential customers on computer equipment given their income and occupation.
- A predictor is constructed that predicts a continuous-valued function, or ordered value, as opposed to a categorical label.
- Regression analysis is a statistical methodology that is most often used for numeric prediction.
- Many classification and prediction methods have been proposed by researchers in machine learning, pattern recognition, and statistics.
- Most algorithms are memory resident, typically assuming a small data size. Recent data mining research has built on such work, developing scalable classification and prediction techniques capable of handling large disk-resident data.

3.1.1 Issues Regarding Classification and Prediction:

1. Preparing the Data for Classification and Prediction:

The following preprocessing steps may be applied to the data to help improve the accuracy, efficiency, and scalability of the classification or prediction process.

(i)Data cleaning:

- This refers to the preprocessing of data in order to remove or reduce *noise* (by applying smoothing techniques) and the treatment of *missingvalues* (e.g., by replacing a missing value with the most commonly occurring value for that attribute, or with the most probable value based on statistics).
- Although most classification algorithms have some mechanisms for handling noisy or missing data, this step can help reduce confusion during learning.

(ii)Relevance analysis:

- Many of the attributes in the data may be *redundant*.
- Correlation analysis can be used to identify whether any two given attributes are statisticallyrelated.
- For example, a strong correlation between attributes A1 and A2 would suggest that one of the two could be removed from further analysis.
- A database may also contain *irrelevant* attributes. Attribute subset selection can be used in these cases to find a reduced set of attributes such that the resulting probability distribution of the data classes is as close as possible to the original distribution obtained using all attributes.
- Hence, relevance analysis, in the form of correlation analysis and attribute subset selection, can be used to detect attributes that do not contribute to the classification or prediction task.
- Such analysis can help improve classification efficiency and scalability.

(iii)Data Transformation And Reduction

- The data may be transformed by normalization, particularly when neural networks or methods involving distance measurements are used in the learning step.
- Normalization involves scaling all values for a given attribute so that they fall within a small specified range, such as -1 to +1 or 0 to 1.
- The data can also be transformed by *generalizing* it to higher-level concepts. Concept hierarchies may be used for this purpose. This is particularly useful for continuous valuedattributes.

- For example, numeric values for the attribute *income* can be generalized to discrete ranges, such as *low*, *medium*, and *high*. Similarly, categorical attributes, like *street*, can be generalized to higher-level concepts, like *city*.
- Data can also be reduced by applying many other methods, ranging from wavelet transformation and principle components analysis to discretization techniques, such as binning, histogram analysis, and clustering.

3.1.2 Comparing Classification and Prediction Methods:

➤ Accuracy:

- The accuracy of a classifier refers to the ability of a given classifier to correctly predict the class label of new or previously unseen data (i.e., tuples without class label information).
- The accuracy of a predictor refers to how well a given predictor can guess the value of the predicted attribute for new or previously unseen data.

➤ Speed:

This refers to the computational costs involved in generating and using the given classifier or predictor.

➤ Robustness:

This is the ability of the classifier or predictor to make correct predictions given noisy data or data with missing values.

➤ Scalability:

This refers to the ability to construct the classifier or predictor efficiently given large amounts of data.

➤ Interpretability:

- This refers to the level of understanding and insight that is provided by the classifier or predictor.
- Interpretability is subjective and therefore more difficult to assess.

3.2 Classification by Decision Tree Induction:

- Decision tree induction is the learning of decision trees from class-labeled training tuples.
- A decision tree is a flowchart-like tree structure, where
 - Each internal node denotes a test on an attribute.
 - Each branch represents an outcome of the test.
 - Each leaf node holds a class label.
 - The topmost node in a tree is the root node.

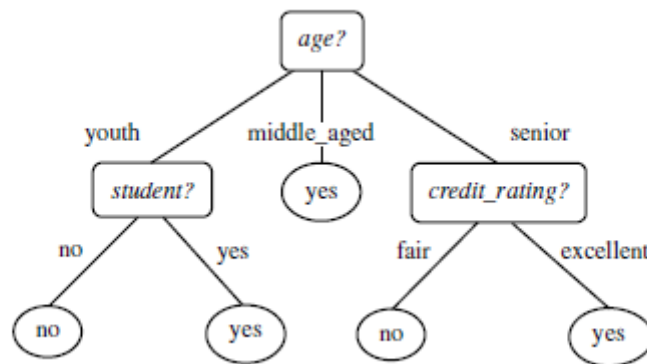

- The construction of decision tree classifiers does not require any domain knowledge or parameter setting, and therefore is appropriate for exploratory knowledge discovery.
- Decision trees can handle high dimensional data.
- Their representation of acquired knowledge in tree form is intuitive and generally easy to assimilate by humans.
- The learning and classification steps of decision tree induction are simple and fast.
- In general, decision tree classifiers have good accuracy.
- Decision tree induction algorithms have been used for classification in many application areas, such as medicine, manufacturing and production, financial analysis, astronomy, and molecular biology.

3.2.1 Algorithm For Decision Tree Induction:

Algorithm: Generate_decision_tree. Generate a decision tree from the training tuples of data partition D .

Input:

- Data partition, D , which is a set of training tuples and their associated class labels;
- *attribute_list*, the set of candidate attributes;
- *Attribute_selection_method*, a procedure to determine the splitting criterion that “best” partitions the data tuples into individual classes. This criterion consists of a *splitting_attribute* and, possibly, either a *split point* or *splitting subset*.

Output: A decision tree.

Method:

```
(1) create a node  $N$ ;  
(2) if tuples in  $D$  are all of the same class,  $C$  then  
(3)   return  $N$  as a leaf node labeled with the class  $C$ ;  
(4) if attribute_list is empty then  
(5)   return  $N$  as a leaf node labeled with the majority class in  $D$ ; // majority voting  
(6) apply Attribute_selection_method( $D$ , attribute_list) to find the “best” splitting_criterion;  
(7) label node  $N$  with splitting_criterion;  
(8) if splitting_attribute is discrete-valued and  
    multiway splits allowed then // not restricted to binary trees  
(9)   attribute_list ← attribute_list – splitting_attribute; // remove splitting_attribute  
(10) for each outcome  $j$  of splitting_criterion  
    // partition the tuples and grow subtrees for each partition  
(11)   let  $D_j$  be the set of data tuples in  $D$  satisfying outcome  $j$ ; // a partition  
(12)   if  $D_j$  is empty then  
(13)     attach a leaf labeled with the majority class in  $D$  to node  $N$ ;  
(14)   else attach the node returned by Generate_decision_tree( $D_j$ , attribute_list) to node  $N$ ;  
    endfor  
(15) return  $N$ ;
```

The algorithm is called with three parameters:

- Data partition
 - Attribute list
 - Attribute selection method
-
- The parameter attribute list is a list of attributes describing the tuples.
 - Attribute selection method specifies a heuristic procedure for selecting the attribute that “best” discriminates the given tuples according to class.
 - The tree starts as a single node, N , representing the training tuples in D .

- If the tuples in D are all of the same class, then node N becomes a leaf and is labeled with that class.
- All of the terminating conditions are explained at the end of the algorithm.
- Otherwise, the algorithm calls Attribute selection method to determine the splitting criterion.
- The splitting criterion tells us which attribute to test at node N by determining the “best” way to separate or partition the tuples in D into individual classes.

There are three possible scenarios. Let A be the splitting attribute. A has v distinct values, $\{a_1, a_2, \dots, a_v\}$, based on the training data.

1 A is discrete-valued:

- In this case, the outcomes of the test at node N correspond directly to the known values of A .
- A branch is created for each known value, a_j , of A and labeled with that value.
- A need not be considered in any future partitioning of the tuples.

2 A is continuous-valued:

In this case, the test at node N has two possible outcomes, corresponding to the conditions $A \leq \text{split point}$ and $A > \text{split point}$, respectively where split point is the split-point returned by Attribute selection method as part of the splitting criterion.

3 A is discrete-valued and a binary tree must be produced:

The test at node N is of the form “ $A \in SA?$ ”.

SA is the splitting subset for A , returned by Attribute selection method as part of the splitting criterion. It is a subset of the known values of A .

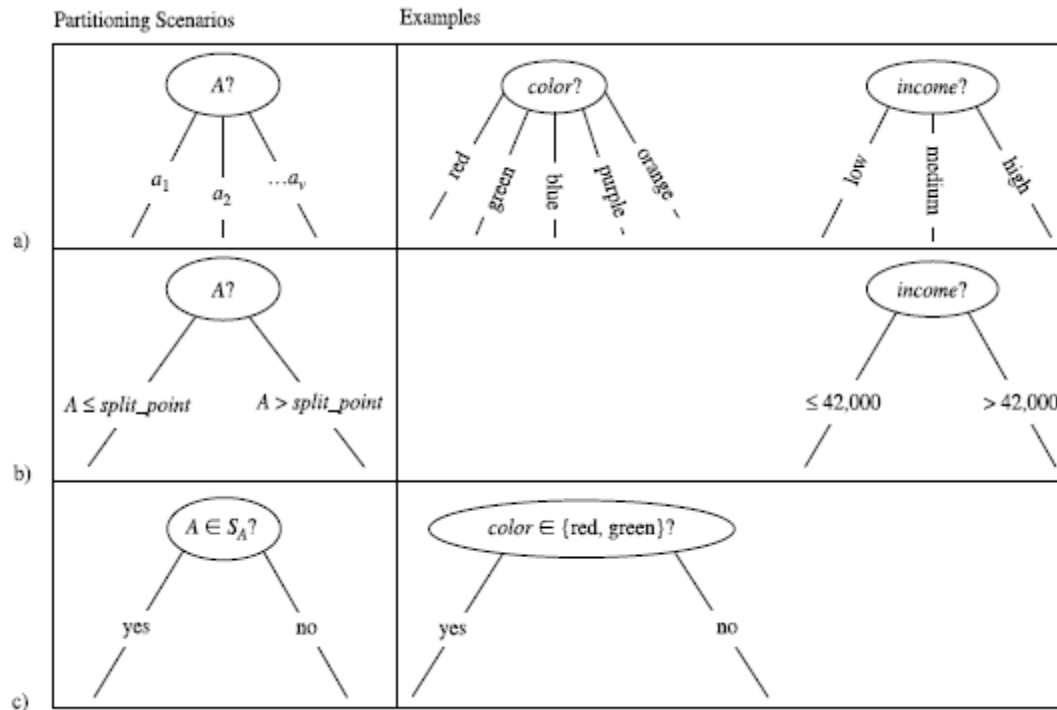

(a) If A is Discrete valued (b) If A is continuous valued (c) If A is discrete-valued and a binary tree must be produced:

3.3 Bayesian Classification:

- Bayesian classifiers are statistical classifiers.
- They can predict class membership probabilities, such as the probability that a given tuple belongs to a particular class.
- Bayesian classification is based on Bayes' theorem.

3.3.1 Bayes' Theorem:

- Let X be a data tuple. In Bayesian terms, X is considered "evidence." and it is described by measurements made on a set of n attributes.

- Let H be some hypothesis, such as that the data tuple X belongs to a specified class C .
- For classification problems, we want to determine $P(H|X)$, the probability that the hypothesis H holds given the “evidence” or observed data tuple X .
- $P(H|X)$ is the posterior probability, or a posteriori probability, of H conditioned on X .
- Bayes’ theorem is useful in that it provides a way of calculating the posterior probability, $P(H|X)$, from $P(H)$, $P(X|H)$, and $P(X)$.

$$P(H|X) = \frac{P(X|H)P(H)}{P(X)}.$$

3.3.2 Naïve Bayesian Classification:

The naïve Bayesian classifier, or simple Bayesian classifier, works as follows:

1. Let D be a training set of tuples and their associated class labels. As usual, each tuple is represented by an n -dimensional attribute vector, $X = (x_1, x_2, \dots, x_n)$, depicting n measurements made on the tuple from n attributes, respectively, A_1, A_2, \dots, A_n .

2. Suppose that there are m classes, C_1, C_2, \dots, C_m . Given a tuple, X , the classifier will predict that X belongs to the class having the highest posterior probability, conditioned on X .

That is, the naïve Bayesian classifier predicts that tuple X belongs to the class C_i if and only if

$$P(C_i|X) > P(C_j|X) \quad \text{for } 1 \leq j \leq m, j \neq i.$$

Thus we maximize $P(C_i|X)$. The class C_i for which $P(C_i|X)$ is maximized is called the maximum posteriori hypothesis. By Bayes’ theorem

$$P(C_i|X) = \frac{P(X|C_i)P(C_i)}{P(X)}.$$

3. As $P(X)$ is constant for all classes, only $P(X|C_i)P(C_i)$ need be maximized. If the class prior probabilities are not known, then it is commonly assumed that the classes are equally likely, that is, $P(C_1) = P(C_2) = \dots = P(C_m)$, and we would therefore maximize $P(X|C_i)$. Otherwise, we maximize $P(X|C_i)P(C_i)$.

4. Given data sets with many attributes, it would be extremely computationally expensive to compute $P(X|C_i)$. In order to reduce computation in evaluating $P(X|C_i)$, the naive assumption of class conditional independence is made. This presumes that the values of the attributes are conditionally independent of one another, given the class label of the tuple. Thus,

$$\begin{aligned} P(X|C_i) &= \prod_{k=1}^n P(x_k|C_i) \\ &= P(x_1|C_i) \times P(x_2|C_i) \times \cdots \times P(x_n|C_i). \end{aligned}$$

We can easily estimate the probabilities $P(x_1|C_i)$, $P(x_2|C_i)$, ..., $P(x_n|C_i)$ from the training tuples. For each attribute, we look at whether the attribute is categorical or continuous-valued. For instance, to compute $P(X|C_i)$, we consider the following:

- If A_k is categorical, then $P(x_k|C_i)$ is the number of tuples of class C_i in D having the value x_k for A_k , divided by $|C_{i,D}|$ the number of tuples of class C_i in D .
- If A_k is continuous-valued, then we need to do a bit more work, but the calculation is pretty straightforward.

A continuous-valued attribute is typically assumed to have a Gaussian distribution with a mean μ and standard deviation σ , defined by

$$g(x, \mu, \sigma) = \frac{1}{\sqrt{2\pi}\sigma} e^{-\frac{(x-\mu)^2}{2\sigma^2}},$$

$$P(x_k|C_i) = g(x_k, \mu_{C_i}, \sigma_{C_i}).$$

5. In order to predict the class label of X , $P(X_j|C_i)P(C_i)$ is evaluated for each class C_i .

The classifier predicts that the class label of tuple X is the class C_i if and only if

$$P(X|C_i)P(C_i) > P(X|C_j)P(C_j) \quad \text{for } 1 \leq j \leq m, j \neq i.$$

3.4 A Multilayer Feed-Forward Neural Network:

- The backpropagation algorithm performs learning on a multilayer feed-forward neural network.
- It iteratively learns a set of weights for prediction of the class label of tuples.
- A multilayer feed-forward neural network consists of an input layer, one or more hidden layers, and an output layer.

Example:

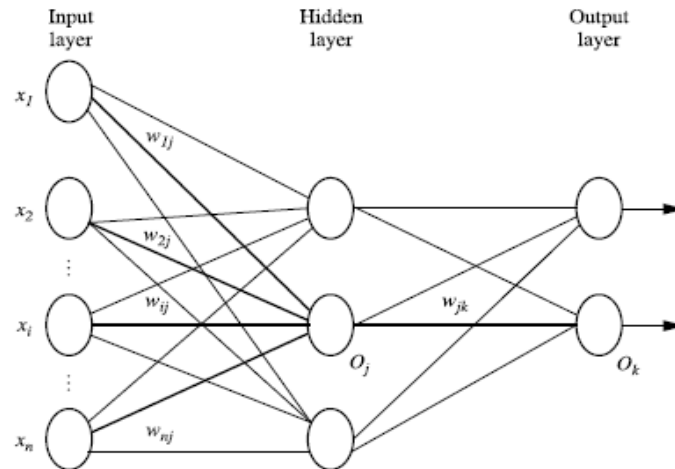

- The inputs to the network correspond to the attributes measured for each training tuple. The inputs are fed simultaneously into the units making up the input layer. These inputs pass through the input layer and are then weighted and fed simultaneously to a second layer known as a hidden layer.
- The outputs of the hidden layer units can be input to another hidden layer, and so on. The number of hidden layers is arbitrary.
- The weighted outputs of the last hidden layer are input to units making up the output layer, which emits the network's prediction for given tuples

3.4.1 Classification by Backpropagation:

- Backpropagation is a neural network learning algorithm.
- A neural network is a set of connected input/output units in which each connection has a weight associated with it.
- During the learning phase, the network learns by adjusting the weights so as to be able to predict the correct class label of the input tuples.
- Neural network learning is also referred to as connectionist learning due to the connections between units.

- Neural networks involve long training times and are therefore more suitable for applications where this is feasible.
- Backpropagation learns by iteratively processing a data set of training tuples, comparing the network's prediction for each tuple with the actual known target value.
- The target value may be the known class label of the training tuple (for classification problems) or a continuous value (for prediction).
- For each training tuple, the weights are modified so as to minimize the mean squared error between the network's prediction and the actual target value. These modifications are made in the "backwards" direction, that is, from the output layer, through each hidden layer down to the first hidden layer hence the name is backpropagation.
- Although it is not guaranteed, in general the weights will eventually converge, and the learning process stops.

Advantages:

- It includes their high tolerance of noisy data as well as their ability to classify patterns on which they have not been trained.
- They can be used when you may have little knowledge of the relationships between attributes and classes.
- They are well-suited for continuous-valued inputs and outputs, unlike most decision tree algorithms.
- They have been successful on a wide array of real-world data, including handwritten character recognition, pathology and laboratory medicine, and training a computer to pronounce English text.
- Neural network algorithms are inherently parallel; parallelization techniques can be used to speed up the computation process.

Process:

Initialize the weights:

The weights in the network are initialized to small random numbers ranging from -1.0 to 1.0, or -0.5 to 0.5. Each unit has a *bias* associated with it. The biases are similarly initialized to small random numbers.

Each training tuple, X , is processed by the following steps.

Propagate the inputs forward:

First, the training tuple is fed to the input layer of the network. The inputs pass through the input units, unchanged. That is, for an input unit j , its output, O_j , is equal to its input value, I_j . Next, the net input and output of each unit in the hidden and output layers are computed. The net input to a unit in the hidden or output layers is computed as a linear combination of its inputs.

Each such unit has a number of inputs to it that are, in fact, the outputs of the units connected to it in the previous layer. Each connection has a weight. To compute the net input to the unit, each input connected to the unit is multiplied by its corresponding weight, and this is summed.

$$I_j = \sum_i w_{ij} O_i + \theta_j,$$

where $w_{i,j}$ is the weight of the connection from unit i in the previous layer to unit j ;

O_i is the output of unit i from the previous layer

θ_j is the bias of the unit & it acts as a threshold in that it serves to vary the activity of the unit.

Each unit in the hidden and output layers takes its net input and then applies an activation function to it.

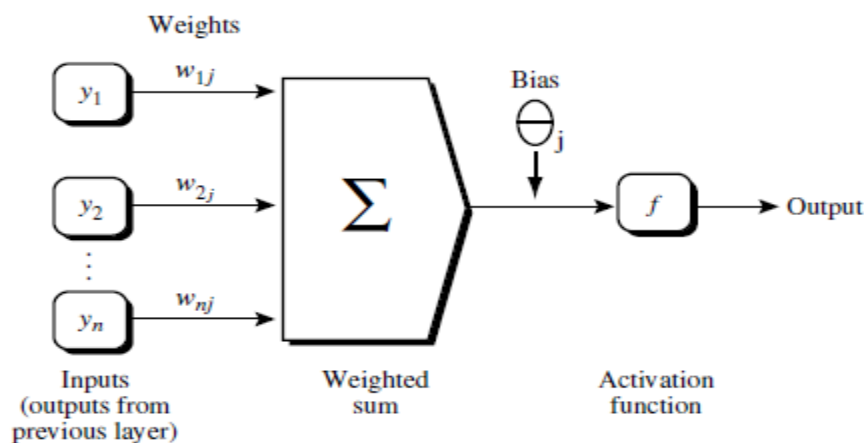

Backpropagate the error:

The error is propagated backward by updating the weights and biases to reflect the error of the network's prediction. For a unit j in the output layer, the error Err_j is computed by

$$Err_j = O_j(1 - O_j)(T_j - O_j)$$

where O_j is the actual output of unit j , and T_j is the known target value of the given training tuple.

The error of a hidden layer unit j is

$$Err_j = O_j(1 - O_j) \sum_k Err_k w_{jk}$$

where w_{jk} is the weight of the connection from unit j to a unit k in the next higher layer, and Err_k is the error of unit k .

Weights are updated by the following equations, where Δw_{ij} is the change in weight w_{ij} :

$$\Delta w_{ij} = (l) Err_j O_i$$

$$w_{ij} = w_{ij} + \Delta w_{ij}$$

Biases are updated by the following equations below

$$\Delta \theta_j = (l) Err_j$$

$$\theta_j = \theta_j + \Delta \theta_j$$

Algorithm:

Input:

- D , a data set consisting of the training tuples and their associated target values;
- l , the learning rate;
- $network$, a multilayer feed-forward network.

Output: A trained neural network.

Method:

```
(1) Initialize all weights and biases in  $network$ ;  
(2) while terminating condition is not satisfied {  
(3)   for each training tuple  $X$  in  $D$  {  
(4)     // Propagate the inputs forward:  
(5)     for each input layer unit  $j$  {  
(6)        $O_j = I_j$ ; // output of an input unit is its actual input value  
(7)     for each hidden or output layer unit  $j$  {  
(8)        $I_j = \sum_i w_{ij} O_i + \theta_j$ ; // compute the net input of unit  $j$  with respect to the  
        previous layer,  $i$   
(9)        $O_j = \frac{1}{1+e^{-I_j}}$ ; } // compute the output of each unit  $j$   
(10)    // Backpropagate the errors:  
(11)    for each unit  $j$  in the output layer  
(12)       $Err_j = O_j(1 - O_j)(T_j - O_j)$ ; // compute the error  
(13)    for each unit  $j$  in the hidden layers, from the last to the first hidden layer  
(14)       $Err_j = O_j(1 - O_j) \sum_k Err_k w_{jk}$ ; // compute the error with respect to the  
        next higher layer,  $k$   
(15)    for each weight  $w_{ij}$  in  $network$  {  
(16)       $\Delta w_{ij} = (l)Err_j O_i$ ; // weight increment  
(17)       $w_{ij} = w_{ij} + \Delta w_{ij}$ ; } // weight update  
(18)    for each bias  $\theta_j$  in  $network$  {  
(19)       $\Delta \theta_j = (l)Err_j$ ; // bias increment  
(20)       $\theta_j = \theta_j + \Delta \theta_j$ ; } // bias update  
(21)    } }
```

3.5 k-Nearest-Neighbor Classifier:

- Nearest-neighbor classifiers are based on learning by analogy, that is, by comparing a given test tuple with training tuples that are similar to it.
- The training tuples are described by n attributes. Each tuple represents a point in an n -dimensional space. In this way, all of the training tuples are stored in an n -dimensional pattern space. When given an unknown tuple, a k -nearest-neighbor classifier searches the pattern space for the k training tuples that are closest to the unknown tuple. These k training tuples are the k nearest neighbors of the unknown tuple.

- Closeness is defined in terms of a distance metric, such as Euclidean distance.
- The Euclidean distance between two points or tuples, say, $X_1 = (x_{11}, x_{12}, \dots, x_{1n})$ and $X_2 = (x_{21}, x_{22}, \dots, x_{2n})$, is

$$dist(X_1, X_2) = \sqrt{\sum_{i=1}^n (x_{1i} - x_{2i})^2}.$$

In other words, for each numeric attribute, we take the difference between the corresponding values of that attribute in tuple X_1 and in tuple X_2 , square this difference, and accumulate it.

The square root is taken of the total accumulated distance count.

Min-Max normalization can be used to transform a value v of a numeric attribute A to v_0 in the range $[0, 1]$ by computing

$$v' = \frac{v - \min_A}{\max_A - \min_A},$$

where \min_A and \max_A are the minimum and maximum values of attribute A

- For k -nearest-neighbor classification, the unknown tuple is assigned the most common class among its k nearest neighbors.
- When $k = 1$, the unknown tuple is assigned the class of the training tuple that is closest to it in pattern space.
- Nearest neighbor classifiers can also be used for prediction, that is, to return a real-valued prediction for a given unknown tuple.
- In this case, the classifier returns the average value of the real-valued labels associated with the k nearest neighbors of the unknown tuple.

3.6 Other Classification Methods:

3.6.1 Genetic Algorithms:

Genetic algorithms attempt to incorporate ideas of natural evolution. In general, genetic learning starts as follows.

- An initial population is created consisting of randomly generated rules. Each rule can be represented by a string of bits. As a simple example, suppose that samples in a given

training set are described by two Boolean attributes, A_1 and A_2 , and that there are two classes, C_1 and C_2 .

- The rule “IF A_1 AND NOT A_2 THEN C_2 ” can be encoded as the bit string “100,” where the two leftmost bits represent attributes A_1 and A_2 , respectively, and the rightmost bit represents the class.
- Similarly, the rule “IF NOT A_1 AND NOT A_2 THEN C_1 ” can be encoded as “001.”
- If an attribute has k values, where $k > 2$, then k bits may be used to encode the attribute’s values.

Classes can be encoded in a similar fashion.

- Based on the notion of survival of the fittest, a new population is formed to consist of the fittest rules in the current population, as well as offspring of these rules.
- Typically, the fitness of a rule is assessed by its classification accuracy on a set of training samples.
- Offspring are created by applying genetic operators such as crossover and mutation.
- In crossover, substrings from pairs of rules are swapped to form new pairs of rules.
- In mutation, randomly selected bits in a rule’s string are inverted.
- The process of generating new populations based on prior populations of rules continues until a population, P , evolves where each rule in P satisfies a pre specified fitness threshold.
- Genetic algorithms are easily parallelizable and have been used for classification as well as other optimization problems. In data mining, they may be used to evaluate the fitness of other algorithms.

3.6.2 Fuzzy Set Approaches:

- Fuzzy logic uses truth values between 0.0 and 1.0 to represent the degree of membership that a certain value has in a given category. Each category then represents a fuzzy set.
- Fuzzy logic systems typically provide graphical tools to assist users in converting attribute values to fuzzy truth values.
- Fuzzy set theory is also known as possibility theory.

- It was proposed by LotfiZadeh in1965 as an alternative to traditional two-value logic and probability theory.
- It lets usworkat a high level of abstraction and offers a means for dealing with imprecise measurementof data.
- Most important, fuzzy set theory allows us to dealwith vague or inexact facts.
- Unlike the notion of traditional “crisp” sets where anelement either belongs to a set S or its complement, in fuzzy set theory, elements canbelong to more than one fuzzy set.
- Fuzzy set theory is useful for data mining systems performing rule-based classification.
- It provides operations for combining fuzzy measurements.
- Several procedures exist for translating the resulting fuzzy output into a *defuzzified*or crisp value that is returned by the system.
- Fuzzy logic systems have been used in numerous areas for classification, including market research, finance, health care, and environmental engineering.

Example:

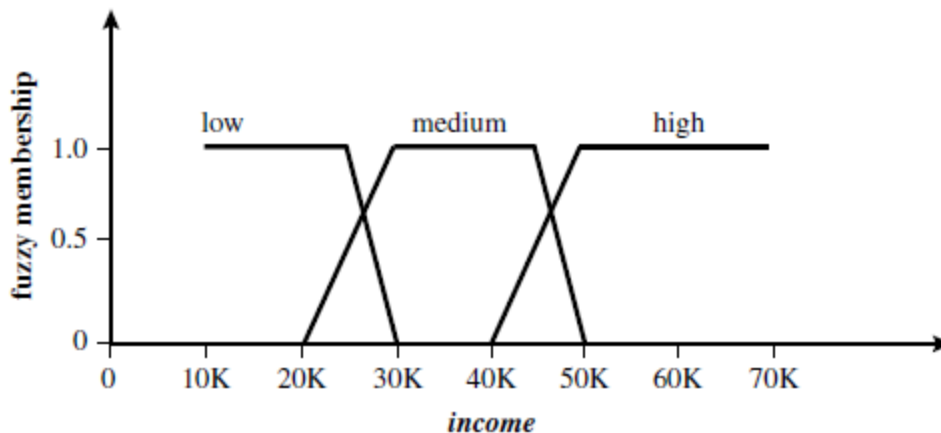

3.7 Regression Analysis:

- Regression analysis can be used to model the relationship between one or more independent or predictor variables and a dependent or response variable which is continuous-valued.
- In the context of data mining, the predictor variables are the attributes of interest describing the tuple (i.e., making up the attribute vector).
- In general, the values of the predictor variables are known.

- The response variable is what we want to predict.

3.7.1 Linear Regression:

- Straight-line regression analysis involves a response variable, y , and a single predictor variable x .
- It is the simplest form of regression, and models y as a linear function of x .

That is, $y = b + wx$

where the variance of y is assumed to be constant

b and w are regression coefficients specifying the Y-intercept and slope of the line.

- The regression coefficients, w and b , can also be thought of as weights, so that we can equivalently write, $y = w_0 + w_1x$
- These coefficients can be solved for by the method of least squares, which estimates the best-fitting straight line as the one that minimizes the error between the actual data and the estimate of the line.
- Let D be a training set consisting of values of predictor variable, x , for some population and their associated values for response variable, y . The training set contains $|D|$ data points of the form $(x_1, y_1), (x_2, y_2), \dots, (x_{|D|}, y_{|D|})$.

The regression coefficients can be estimated using this method with the following equations:

$$w_1 = \frac{\sum_{i=1}^{|D|} (x_i - \bar{x})(y_i - \bar{y})}{\sum_{i=1}^{|D|} (x_i - \bar{x})^2}$$

$$w_0 = \bar{y} - w_1\bar{x}$$

where \bar{x} is the mean value of $x_1, x_2, \dots, x_{|D|}$, and \bar{y} is the mean value of $y_1, y_2, \dots, y_{|D|}$.

The coefficients w_0 and w_1 often provide good approximations to otherwise complicated regression equations.

3.7.2 Multiple Linear Regression:

- It is an extension of straight-line regression so as to involve more than one predictor variable.

- It allows response variable y to be modeled as a linear function of, say, n predictor variables or attributes, A_1, A_2, \dots, A_n , describing a tuple, X .
- An example of a multiple linear regression model based on two predictor attributes or variables, A_1 and A_2 , is $y = w_0 + w_1x_1 + w_2x_2$

where x_1 and x_2 are the values of attributes A_1 and A_2 , respectively, in X .

- Multiple regression problems are instead commonly solved with the use of statistical software packages, such as SAS, SPSS, and S-Plus.

3.7.3 Nonlinear Regression:

- It can be modeled by adding polynomial terms to the basic linear model.
- By applying transformations to the variables, we can convert the nonlinear model into a linear one that can then be solved by the method of least squares.
- Polynomial Regression is a special case of multiple regression. That is, the addition of high-order terms like x^2, x^3 , and so on, which are simple functions of the single variable, x , can be considered equivalent to adding new independent variables.

Transformation of a polynomial regression model to a linear regression model:

Consider a cubic polynomial relationship given by

$$y = w_0 + w_1x + w_2x^2 + w_3x^3$$

To convert this equation to linear form, we define new variables:

$$x_1 = x, x_2 = x^2, x_3 = x^3$$

It can then be converted to linear form by applying the above assignments, resulting in the equation $y = w_0 + w_1x_1 + w_2x_2 + w_3x_3$

which is easily solved by the method of least squares using software for regression analysis.

3.8 Classifier Accuracy:

- The accuracy of a classifier on a given test set is the percentage of test set tuples that are correctly classified by the classifier.
- In the pattern recognition literature, this is also referred to as the overall recognition rate of the classifier, that is, it reflects how well the classifier recognizes tuples of the various classes.

- The error rate or misclassification rate of a classifier, M , which is simply $1 - \text{Acc}(M)$, where $\text{Acc}(M)$ is the accuracy of M .
- The confusion matrix is a useful tool for analyzing how well your classifier can recognize tuples of different classes.
- True positives refer to the positive tuples that were correctly labeled by the classifier.
- True negatives are the negative tuples that were correctly labeled by the classifier.
- False positives are the negative tuples that were incorrectly labeled.
- How well the classifier can recognize, for this sensitivity and specificity measures can be used.

Accuracy is a function of sensitivity and specificity.

$$\text{accuracy} = \text{sensitivity} \frac{\text{pos}}{(\text{pos} + \text{neg})} + \text{specificity} \frac{\text{neg}}{(\text{pos} + \text{neg})}.$$

$$\text{sensitivity} = \frac{t_pos}{pos}$$

$$\text{specificity} = \frac{t_neg}{neg}$$

$$\text{precision} = \frac{t_pos}{(t_pos + f_pos)}$$

where t_pos is the number of true positives

pos is the number of positive tuples

t_neg is the number of true negatives

neg is the number of negative tuples,

f_pos is the number of false positives

Chapter-4

4.1 Cluster Analysis:

- The process of grouping a set of physical or abstract objects into classes of similar objects is called clustering.
- A cluster is a collection of data objects that are similar to one another within the same cluster and are dissimilar to the objects in other clusters.
- A cluster of data objects can be treated collectively as one group and so may be considered as a form of data compression.
- Cluster analysis tools based on k-means, k-medoids, and several methods have also been built into many statistical analysis software packages or systems, such as S-Plus, SPSS, and SAS.

4.1.1 Applications:

- Cluster analysis has been widely used in numerous applications, including market research, pattern recognition, data analysis, and image processing.
- In business, clustering can help marketers discover distinct groups in their customer bases and characterize customer groups based on purchasing patterns.
- In biology, it can be used to derive plant and animal taxonomies, categorize genes with similar functionality, and gain insight into structures inherent in populations.
- Clustering may also help in the identification of areas of similar land use in an earth observation database and in the identification of groups of houses in a city according to house type, value, and geographic location, as well as the identification of groups of automobile insurance policy holders with a high average claim cost.
- Clustering is also called data segmentation in some applications because clustering partitions large data sets into groups according to their *similarity*.

- Clustering can also be used for outlier detection, Applications of outlier detection include the detection of credit card fraud and the monitoring of criminal activities in electronic commerce.

4.1.2 Typical Requirements Of Clustering InData Mining:

➤ **Scalability:**

Many clustering algorithms work well on small data sets containing fewer than several hundred data objects; however, a large database may contain millions of objects. Clustering on a sample of a given large data set may lead to biased results.

Highly scalable clustering algorithms are needed.

➤ **Ability to deal with different types of attributes:**

Many algorithms are designed to cluster interval-based (numerical) data. However, applications may require clustering other types of data, such as binary, categorical (nominal), and ordinal data, or mixtures of these data types.

➤ **Discovery of clusters with arbitrary shape:**

Many clustering algorithms determine clusters based on Euclidean or Manhattan distance measures. Algorithms based on such distance measures tend to find spherical clusters with similar size and density.

However, a cluster could be of any shape. It is important to develop algorithms that can detect clusters of arbitrary shape.

➤ **Minimal requirements for domain knowledge to determine input parameters:**

Many clustering algorithms require users to input certain parameters in cluster analysis (such as the number of desired clusters). The clustering results can be quite sensitive to input parameters. Parameters are often difficult to determine, especially for data sets containing high-dimensional objects. This not only burdens users, but it also makes the quality of clustering difficult to control.

➤ **Ability to deal with noisy data:**

Most real-world databases contain outliers or missing, unknown, or erroneous data.

Some clustering algorithms are sensitive to such data and may lead to clusters of poor quality.

➤ **Incremental clustering and insensitivity to the order of input records:**

Some clustering algorithms cannot incorporate newly inserted data (i.e., database updates) into existing clustering structures and, instead, must determine a new clustering from scratch. Some clustering algorithms are sensitive to the order of input data.

That is, given a set of data objects, such an algorithm may return dramatically different clusterings depending on the order of presentation of the input objects.

It is important to develop incremental clustering algorithms and algorithms that are insensitive to the order of input.

➤ **High dimensionality:**

A database or a data warehouse can contain several dimensions or attributes. Many clustering algorithms are good at handling low-dimensional data, involving only two to three dimensions. Human eyes are good at judging the quality of clustering for up to three dimensions. Finding clusters of data objects in high-dimensional space is challenging, especially considering that such data can be sparse and highly skewed.

➤ **Constraint-based clustering:**

Real-world applications may need to perform clustering under various kinds of constraints. Suppose that your job is to choose the locations for a given number of new automatic banking machines (ATMs) in a city. To decide upon this, you may cluster households while considering constraints such as the city's rivers and highway networks, and the type and number of customers per cluster. A challenging task is to find groups of data with good clustering behavior that satisfy specified constraints.

➤ **Interpretability and usability:**

Users expect clustering results to be interpretable, comprehensible, and usable. That is, clustering may need to be tied to specific semantic interpretations and applications. It is important to study how an application goal may influence the selection of clustering features and methods.

4.2 Major Clustering Methods:

- Partitioning Methods
- Hierarchical Methods

- Density-Based Methods
- Grid-Based Methods
- Model-Based Methods

4.2.1 Partitioning Methods:

A partitioning method constructs k partitions of the data, where each partition represents a cluster and $k \leq n$. That is, it classifies the data into k groups, which together satisfy the following requirements:

- Each group must contain at least one object, and
- Each object must belong to exactly one group.

A partitioning method creates an initial partitioning. It then uses an iterative relocation technique that attempts to improve the partitioning by moving objects from one group to another.

The general criterion of a good partitioning is that objects in the same cluster are close or related to each other, whereas objects of different clusters are far apart or very different.

4.2.2 Hierarchical Methods:

A hierarchical method creates a hierarchical decomposition of the given set of data objects. A hierarchical method can be classified as being either agglomerative or divisive, based on how the hierarchical decomposition is formed.

- ❖ The agglomerative approach, also called the bottom-up approach, starts with each object forming a separate group. It successively merges the objects or groups that are close to one another, until all of the groups are merged into one or until a termination condition holds.
- ❖ The divisive approach, also called the top-down approach, starts with all of the objects in the same cluster. In each successive iteration, a cluster is split up into smaller clusters, until eventually each object is in one cluster, or until a termination condition holds.

Hierarchical methods suffer from the fact that once a step (merge or split) is done, it can never be undone. This rigidity is useful in that it leads to smaller computation costs by not having to worry about a combinatorial number of different choices.

There are two approaches to improving the quality of hierarchical clustering:

- ❖ Perform careful analysis of object “linkages” at each hierarchical partitioning, such as in Chameleon, or
- ❖ Integrate hierarchical agglomeration and other approaches by first using a hierarchical agglomerative algorithm to group objects into microclusters, and then performing macroclustering on the microclusters using another clustering method such as iterative relocation.

4.2.3 Density-based methods:

- ❖ Most partitioning methods cluster objects based on the distance between objects. Such methods can find only spherical-shaped clusters and encounter difficulty at discovering clusters of arbitrary shapes.
- ❖ Other clustering methods have been developed based on the notion of density. Their general idea is to continue growing the given cluster as long as the density in the neighborhood exceeds some threshold; that is, for each data point within a given cluster, the neighborhood of a given radius has to contain at least a minimum number of points. Such a method can be used to filter out noise (outliers) and discover clusters of arbitrary shape.
- ❖ DBSCAN and its extension, OPTICS, are typical density-based methods that grow clusters according to a density-based connectivity analysis. DENCLUE is a method that clusters objects based on the analysis of the value distributions of density functions.

4.2.4 Grid-Based Methods:

- ❖ Grid-based methods quantize the object space into a finite number of cells that form a grid structure.

- ❖ All of the clustering operations are performed on the grid structure i.e., on the quantized space. The main advantage of this approach is its fast processing time, which is typically independent of the number of data objects and dependent only on the number of cells in each dimension in the quantized space.
- ❖ STING is a typical example of a grid-based method. Wave Cluster applies wavelet transformation for clustering analysis and is both grid-based and density-based.

4.2.5 Model-Based Methods:

- ❖ Model-based methods hypothesize a model for each of the clusters and find the best fit of the data to the given model.
- ❖ A model-based algorithm may locate clusters by constructing a density function that reflects the spatial distribution of the data points.
- ❖ It also leads to a way of automatically determining the number of clusters based on standard statistics, taking “noise” or outliers into account and thus yielding robust clustering methods.

4.3 Tasks in Data Mining:

- Clustering High-Dimensional Data
- Constraint-Based Clustering

4.3.1 Clustering High-Dimensional Data:

- It is a particularly important task in cluster analysis because many applications require the analysis of objects containing a large number of features or dimensions.
- For example, text documents may contain thousands of terms or keywords as features, and DNA micro array data may provide information on the expression levels of thousands of genes under hundreds of conditions.
- Clustering high-dimensional data is challenging due to the curse of dimensionality.
- Many dimensions may not be relevant. As the number of dimensions increases, the data become increasingly sparse so that the distance measurement between pairs of points become meaningless and the average density of points anywhere in the data is likely to be low. Therefore, a different clustering methodology needs to be developed for high-dimensional data.

- CLIQUE and PROCLUS are two influential subspace clustering methods, which search for clusters in subspaces of the data, rather than over the entire data space.
- Frequent pattern-based clustering, another clustering methodology, extracts distinct frequent patterns among subsets of dimensions that occur frequently. It uses such patterns to group objects and generate meaningful clusters.

4.3.2 Constraint-Based Clustering:

- It is a clustering approach that performs clustering by incorporation of user-specified or application-oriented constraints.
- A constraint expresses a user's expectation or describes properties of the desired clustering results, and provides an effective means for communicating with the clustering process.
- Various kinds of constraints can be specified, either by a user or as per application requirements.
- Spatial clustering employs with the existence of obstacles and clustering under user-specified constraints. In addition, semi-supervised clustering employs pairwise constraints in order to improve the quality of the resulting clustering.

4.4 Classical Partitioning Methods:

The most well-known and commonly used partitioning methods are

- ❖ The k -Means Method
- ❖ k -Medoids Method

4.4.1 Centroid-Based Technique: The K -Means Method:

The k -means algorithm takes the input parameter, k , and partitions a set of n objects into k clusters so that the resulting intracluster similarity is high but the intercluster similarity is low.

Cluster similarity is measured in regard to the mean value of the objects in a cluster, which can be viewed as the cluster's centroid or center of gravity.

The k -means algorithm proceeds as follows.

- First, it randomly selects k of the objects, each of which initially represents a cluster mean or center.
- For each of the remaining objects, an object is assigned to the cluster to which it is the most similar, based on the distance between the object and the cluster mean.
- It then computes the new mean for each cluster.
- This process iterates until the criterion function converges.

Typically, the square-error criterion is used, defined as

$$E = \sum_{i=1}^k \sum_{p \in C_i} |p - m_i|^2,$$

where E is the sum of the square error for all objects in the data set

p is the point in space representing a given object

m_i is the mean of cluster C_i

4.4.1 The k-means partitioning algorithm:

The k -means algorithm for partitioning, where each cluster's center is represented by the mean value of the objects in the cluster.

Input:

- k : the number of clusters,
- D : a data set containing n objects.

Output: A set of k clusters.

Method:

- (1) arbitrarily choose k objects from D as the initial cluster centers;
- (2) repeat
- (3) (re)assign each object to the cluster to which the object is the most similar, based on the mean value of the objects in the cluster;
- (4) update the cluster means, i.e., calculate the mean value of the objects for each cluster;
- (5) until no change;

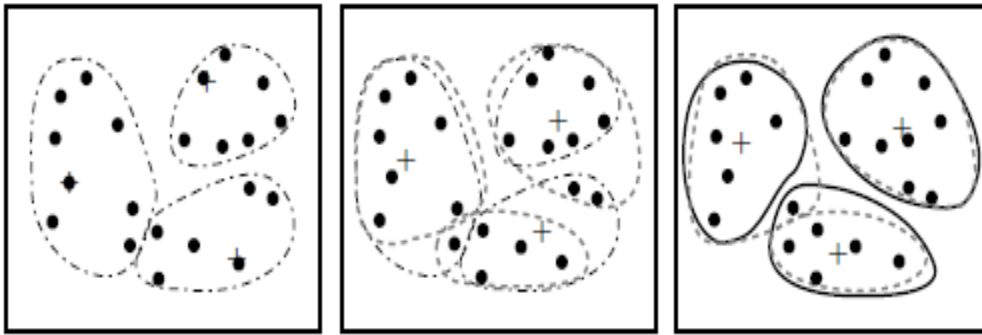

Clustering of a set of objects based on the k -means method

4.4.2 The k -Medoids Method:

- The k -means algorithm is sensitive to outliers because an object with an extremely large value may substantially distort the distribution of data. This effect is particularly exacerbated due to the use of the square-error function.
- Instead of taking the mean value of the objects in a cluster as a reference point, we can pick actual objects to represent the clusters, using one representative object per cluster. Each remaining object is clustered with the representative object to which it is the most similar.
- The partitioning method is then performed based on the principle of minimizing the sum of the dissimilarities between each object and its corresponding reference point. That is, an absolute-error criterion is used, defined as

$$E = \sum_{j=1}^k \sum_{p \in C_j} |p - o_j|,$$

where E is the sum of the absolute error for all objects in the data set

p is the point in space representing a given object in cluster C_j

o_j is the representative object of C_j

- The initial representative objects are chosen arbitrarily. The iterative process of replacing representative objects by non representative objects continues as long as the quality of the resulting clustering is improved.
- This quality is estimated using a cost function that measures the average dissimilarity between an object and the representative object of its cluster.
- To determine whether a non representative object, o_j random, is a good replacement for a current representative object, o_j , the following four cases are examined for each of the nonrepresentative objects.

Case 1:

p currently belongs to representative object, o_j . If o_j is replaced by o_{random} as a representative object and p is closest to one of the other representative objects, $o_i, i \neq j$, then p is reassigned to o_i .

Case 2:

p currently belongs to representative object, o_j . If o_j is replaced by o_{random} as a representative object and p is closest to o_{random} , then p is reassigned to o_{random} .

Case 3:

p currently belongs to representative object, $o_i, i \neq j$. If o_j is replaced by o_{random} as a representative object and p is still closest to o_i , then the assignment does not change.

Case 4:

p currently belongs to representative object, $o_i, i \neq j$. If o_j is replaced by o_{random} as a representative object and p is closest to o_{random} , then p is reassigned to o_{random} .

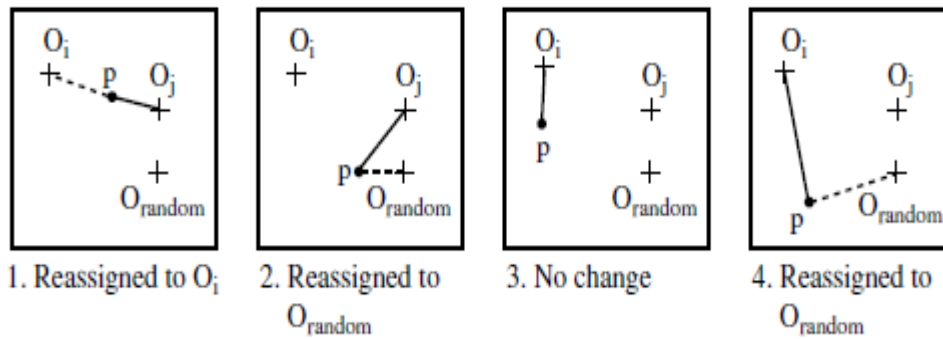

- data object
- + cluster center
- before swapping
- after swapping

Four cases of the cost function for k -medoids clustering

4.4.2 The k -Medoids Algorithm:

The k -medoids algorithm for partitioning based on medoid or central objects.

Input:

- k : the number of clusters,
- D : a data set containing n objects.

Output: A set of k clusters.

Method:

- (1) arbitrarily choose k objects in D as the initial representative objects or seeds;
- (2) repeat
 - (3) assign each remaining object to the cluster with the nearest representative object;
 - (4) randomly select a nonrepresentative object, o_{random} ;
 - (5) compute the total cost, S , of swapping representative object, o_j , with o_{random} ;
 - (6) if $S < 0$ then swap o_j with o_{random} to form the new set of k representative objects;
- (7) until no change;

The k -medoids method is more robust than k -means in the presence of noise and outliers, because a medoid is less influenced by outliers or other extreme values than a mean. However, its processing is more costly than the k -means method.

4.5 Hierarchical Clustering Methods:

- A hierarchical clustering method works by grouping data objects into a tree of clusters.
- The quality of a pure hierarchical clustering method suffers from its inability to perform adjustment once a merge or split decision has been executed. That is, if a particular merge or split decision later turns out to have been a poor choice, the method cannot backtrack and correct it.

Hierarchical clustering methods can be further classified as either agglomerative or divisive, depending on whether the hierarchical decomposition is formed in a bottom-up or top-down fashion.

4.5.1 Agglomerative hierarchical clustering:

- This bottom-up strategy starts by placing each object in its own cluster and then merges these atomic clusters into larger and larger clusters, until all of the objects are in a single cluster or until certain termination conditions are satisfied.
- Most hierarchical clustering methods belong to this category. They differ only in their definition of intercluster similarity.

4.5.2 Divisive hierarchical clustering:

- This top-down strategy does the reverse of agglomerative hierarchical clustering by starting with all objects in one cluster.
- It subdivides the cluster into smaller and smaller pieces, until each object forms a cluster on its own or until it satisfies certain termination conditions, such as a desired number of clusters is obtained or the diameter of each cluster is within a certain threshold.

4.6 Constraint-Based Cluster Analysis:

Constraint-based clustering finds clusters that satisfy user-specified preferences or constraints. Depending on the nature of the constraints, constraint-based clustering may adopt rather different approaches.

There are a few categories of constraints.

➤ **Constraints on individual objects:**

We can specify constraints on the objects to be clustered. In a real estate application, for example, one may like to spatially cluster only those luxury mansions worth over a million dollars. This constraint confines the set of objects to be clustered. It can easily be handled by preprocessing after which the problem reduces to an instance of unconstrained clustering.

➤ **Constraints on the selection of clustering parameters:**

A user may like to set a desired range for each clustering parameter. Clustering parameters are usually quite specific to the given clustering algorithm. Examples of parameters include k , the desired number of clusters in a k -means algorithm; or e the radius and the minimum number of points in the DBSCAN algorithm. Although such user-specified parameters may strongly influence the clustering results, they are usually confined to the algorithm itself. Thus, their fine tuning and processing are usually not considered a form of constraint-based clustering.

➤ **Constraints on distance or similarity functions:**

We can specify different distance or similarity functions for specific attributes of the objects to be clustered, or different distance measures for specific pairs of objects. When clustering sportsmen, for example, we may use different weighting schemes for height, body weight, age, and skill level. Although this will likely change the mining results, it may not alter the clustering process per se. However, in some cases, such changes may make the evaluation of the distance function nontrivial, especially when it is tightly intertwined with the clustering process.

➤ **User-specified constraints on the properties of individual clusters:**

A user may like to specify desired characteristics of the resulting clusters, which may strongly influence the clustering process.

➤ **Semi-supervised clustering based on partial supervision:**

The quality of unsupervised clustering can be significantly improved using some weak form of supervision. This may be in the form of pairwise constraints (i.e., pairs of objects labeled as belonging to the same or different cluster). Such a constrained clustering process is called semi-supervised clustering.

4.7 Outlier Analysis:

- There exist data objects that do not comply with the general behavior or model of the data. Such data objects, which are grossly different from or inconsistent with the remaining set of data, are called outliers.
- Many data mining algorithms try to minimize the influence of outliers or eliminate them all together. This, however, could result in the loss of important hidden information because one person's noise could be another person's signal. In other words, the outliers may be of particular interest, such as in the case of fraud detection, where outliers may indicate fraudulent activity. Thus, outlier detection and analysis is an interesting data mining task, referred to as outlier mining.
- It can be used in fraud detection, for example, by detecting unusual usage of credit cards or telecommunication services. In addition, it is useful in customized marketing for identifying the spending behavior of customers with extremely low or extremely high incomes, or in medical analysis for finding unusual responses to various medical treatments.

Outlier mining can be described as follows: Given a set of n data points or objects and k , the expected number of outliers, find the top k objects that are considerably dissimilar, exceptional, or inconsistent with respect to the remaining data. The outlier mining problem can be viewed as two subproblems:

- Define what data can be considered as inconsistent in a given data set, and
- Find an efficient method to mine the outliers so defined.

Types of outlier detection:

- Statistical Distribution-Based Outlier Detection
- Distance-Based Outlier Detection
- Density-Based Local Outlier Detection
- Deviation-Based Outlier Detection

4.7.1 Statistical Distribution-Based Outlier Detection:

The statistical distribution-based approach to outlier detection assumes a distribution or probability model for the given data set (e.g., a normal or Poisson distribution) and then identifies outliers with respect to the model using a discordancy test. Application of the test requires knowledge of the data set parameters and knowledge of distribution parameters such as the mean and variance and the expected number of outliers.

A statistical discordancy test examines two hypotheses:

- A working hypothesis
- An alternative hypothesis

A working hypothesis, H , is a statement that the entire data set of n objects comes from an initial distribution model, F , that is,

$$H : o_i \in F, \quad \text{where } i = 1, 2, \dots, n.$$

The hypothesis is retained if there is no statistically significant evidence supporting its rejection. A discordancy test verifies whether an object, o_i , is significantly large (or small) in relation to the distribution F . Different test statistics have been proposed for use as a discordancy test, depending on the available knowledge of the data. Assuming that some statistic, T , has been chosen for discordancy testing, and the value of the statistic for object o_i is v_i , then the distribution of T is constructed. Significance probability, $SP(v_i) = \text{Prob}(T > v_i)$, is evaluated. If $SP(v_i)$ is sufficiently small, then o_i is discordant and the working hypothesis is rejected.

An alternative hypothesis, H , which states that o_i comes from another distribution model, G , is adopted. The result is very much dependent on which model F is chosen because o_i may be an outlier under one model and a perfectly valid value under another. The

alternative distribution is very important in determining the power of the test, that is, the probability that the working hypothesis is rejected when o_i is really an outlier.

There are different kinds of alternative distributions.

- **Inherent alternative distribution:**

In this case, the working hypothesis that all of the objects come from distribution F is rejected in favor of the alternative hypothesis that all of the objects arise from another distribution, G :

$H : o_i \in G$, where $i = 1, 2, \dots, n$

F and G may be different distributions or differ only in parameters of the same distribution.

There are constraints on the form of the G distribution in that it must have potential to produce outliers. For example, it may have a different mean or dispersion, or a longer tail.

- **Mixture alternative distribution:**

The mixture alternative states that discordant values are not outliers in the F population, but contaminants from some other population,

G . In this case, the alternative hypothesis is

$$\bar{H} : o_i \in (1 - \lambda)F + \lambda G, \quad \text{where } i = 1, 2, \dots, n.$$

- **Slippage alternative distribution:**

This alternative states that all of the objects (apart from some prescribed small number) arise independently from the initial model, F , with its given parameters, whereas the remaining objects are independent observations from a modified version of F in which the parameters have been shifted.

There are two basic types of procedures for detecting outliers:

Block procedures:

In this case, either all of the suspect objects are treated as outliers or all of them are accepted as consistent.

Consecutive procedures:

An example of such a procedure is the *insideout* procedure. Its main idea is that the object that is least likely to be an outlier is tested first. If it is found to be an outlier, then all of the

more extreme values are also considered outliers; otherwise, the next most extreme object is tested, and so on. This procedure tends to be more effective than block procedures.

4.7.2 Distance-Based Outlier Detection:

The notion of distance-based outliers was introduced to counter the main limitations imposed by statistical methods. An object, o , in a data set, D , is a distance-based (DB) outlier with parameters pct and $dmin$, that is, a $DB(pct;dmin)$ -outlier, if at least a fraction, pct , of the objects in D lie at a distance greater than $dmin$ from o . In other words, rather than relying on statistical tests, we can think of distance-based outliers as those objects that do not have enough neighbors, where neighbors are defined based on distance from the given object. In comparison with statistical-based methods, distance-based outlier detection generalizes the ideas behind discordancy testing for various standard distributions. Distance-based outlier detection avoids the excessive computation that can be associated with fitting the observed distribution into some standard distribution and in selecting discordancy tests.

For many discordancy tests, it can be shown that if an object, o , is an outlier according to the given test, then o is also a $DB(pct, dmin)$ -outlier for some suitably defined pct and $dmin$.

For example, if objects that lie three or more standard deviations from the mean are considered to be outliers, assuming a normal distribution, then this definition can be generalized by a $DB(0.9988, 0.13s)$ outlier.

Several efficient algorithms for mining distance-based outliers have been developed.

Index-based algorithm:

Given a data set, the index-based algorithm uses multidimensional indexing structures, such as R-trees or k-d trees, to search for neighbors of each object o within radius $dmin$ around that object. Let M be the maximum number of objects within the $dmin$ -neighborhood of an outlier. Therefore, once $M+1$ neighbors of object o are found, it is clear that o is not an outlier. This algorithm has a worst-case complexity of $O(n^2k)$, where n is the number of objects in the data set and k is the dimensionality. The index-based algorithm scales well as k increases. However, this complexity evaluation takes only the search time into account, even though the task of building an index in itself can be computationally intensive.

Nested-loop algorithm:

The nested-loop algorithm has the same computational complexity as the index-based algorithm but avoids index structure construction and tries to minimize the number of I/Os. It divides the memory buffer space into two halves and the data set into several logical blocks. By carefully choosing the order in which blocks are loaded into each half, I/O efficiency can be achieved.

Cell-based algorithm:

To avoid $O(n^2)$ computational complexity, a cell-based algorithm was developed for memory-resident data sets. Its complexity is $O(c^k + n)$, where c is a constant depending on the number of cells and k is the dimensionality.

In this method, the data space is partitioned into cells with a side length equal to $\frac{d_{min}}{2\sqrt{k}}$. Each cell has two layers surrounding it. The first layer is one cell thick, while the second is $[2\sqrt{k} - 1]$ cells thick, rounded up to the closest integer. The algorithm counts outliers on a cell-by-cell rather than an object-by-object basis. For a given cell, it accumulates three counts—the number of objects in the cell, in the cell and the first layer together, and in the cell and both layers together. Let's refer to these counts as cell count, cell + 1 layer count, and cell + 2 layers count, respectively.

Let M be the maximum number of outliers that can exist in the d_{min} -neighborhood of an outlier.

- An object, \mathbf{o} , in the current cell is considered an outlier only if cell + 1 layer count is less than or equal to M . If this condition does not hold, then all of the objects in the cell can be removed from further investigation as they cannot be outliers.
- If cell + 2 layers count is less than or equal to M , then all of the objects in the cell are considered outliers. Otherwise, if this number is more than M , then it is possible that some of the objects in the cell may be outliers. To detect these outliers, object-by-object processing is used where, for each object, \mathbf{o} , in the cell, objects in the second layer of \mathbf{o} are examined. For objects in the cell, only those objects having no more than M points in their d_{min} -neighborhoods are outliers. The d_{min} -neighborhood of an object consists of the object's cell, all of its first layer, and some of its second layer.

A variation to the algorithm is linear with respect to n and guarantees that no more than three passes over the data set are required. It can be used for large disk-resident data sets, yet does not scale well for high dimensions.

4.7.3 Density-Based Local Outlier Detection:

Statistical and distance-based outlier detection both depend on the overall or global distribution of the given set of data points, D . However, data are usually not uniformly distributed. These methods encounter difficulties when analyzing data with rather different density distributions.

To define the local outlier factor of an object, we need to introduce the concepts of k -distance, k -distance neighborhood, reachability distance,¹³ and local reachability density.

These are defined as follows:

The k -distance of an object p is the maximal distance that p gets from its k -nearest neighbors. This distance is denoted as $k\text{-distance}(p)$. It is defined as the distance, $d(p, o)$, between p and an object $o \in D$, such that for at least k objects, $o_0 \in D$, it holds that $d(p, o) \leq d(p, o_0)$. That is, there are at least k objects in D that are as close as or closer to p than o , and for at most $k-1$ objects, $o' \in D$, it holds that $d(p, o') < d(p, o)$.

That is, there are at most $k-1$ objects that are closer to p than o . You may be wondering at this point how k is determined. The LOF method links to density-based clustering in that it sets k to the parameter MinPts , which specifies the minimum number of points for use in identifying clusters based on density.

Here, MinPts (as k) is used to define the local neighborhood of an object, p .

The k -distance neighborhood of an object p is denoted $N_{k\text{-distance}(p)}(p)$, or $N_k(p)$ for short. By setting k to MinPts , we get $N_{\text{MinPts}}(p)$. It contains the MinPts -nearest neighbors of p . That is, it contains every object whose distance is not greater than the MinPts -distance of p .

The reachability distance of an object p with respect to object o (where o is within the MinPts -nearest neighbors of p), is defined as reach

$\text{distMinPts}(p, o) = \max\{\text{MinPtsdistance}(o), d(p, o)\}$.

Intuitively, if an object p is far away, then the reachability distance between the two is simply their actual distance. However, if they are sufficiently close (i.e., where p is within the $MinPts$ -distance neighborhood of o), then the actual distance is replaced by the $MinPts$ -distance of o . This helps to significantly reduce the statistical fluctuations of $d(p, o)$ for all of the p close to o .

The higher the value of $MinPts$ is, the more similar is the reachability distance for objects within the same neighborhood.

Intuitively, the local reachability density of p is the inverse of the average reachability density based on the $MinPts$ -nearest neighbors of p . It is defined as

$$lrd_{MinPts}(p) = \frac{|N_{MinPts}(p)|}{\sum_{o \in N_{MinPts}(p)} reach_dist_{MinPts}(p, o)}$$

The local outlier factor (LOF) of p captures the degree to which we call p an outlier.

It is defined as

$$LOF_{MinPts}(p) = \frac{\sum_{o \in N_{MinPts}(p)} \frac{lrd_{MinPts}(o)}{lrd_{MinPts}(p)}}{|N_{MinPts}(p)|}$$

It is the average of the ratio of the local reachability density of p and those of p 's $MinPts$ -nearest neighbors. It is easy to see that the lower p 's local reachability density is, and the higher the local reachability density of p 's $MinPts$ -nearest neighbors are, the higher $LOF(p)$ is.

4.7.4 Deviation-Based Outlier Detection:

Deviation-based outlier detection does not use statistical tests or distance-based measures to identify exceptional objects. Instead, it identifies outliers by examining the main characteristics of objects in a group. Objects that “deviate” from this description are considered outliers. Hence, in this approach the term deviations is typically used to refer to outliers. In this section, we study two techniques for deviation-based outlier detection. The first sequentially compares objects in a set, while the second employs an OLAP data cube approach.

Sequential Exception Technique:

The sequential exception technique simulates the way in which humans can distinguish unusual objects from among a series of supposedly like objects. It uses implicit redundancy of the data. Given a data set, D , of n objects, it builds a sequence of subsets, $\{D_1, D_2, \dots, D_m\}$, of these objects with $2 \leq m \leq n$ such that

$$D_{j-1} \subset D_j, \quad \text{where } D_j \subseteq D.$$

Dissimilarities are assessed between subsets in the sequence. The technique introduces the following key terms.

Exception set:

This is the set of deviations or outliers. It is defined as the smallest subset of objects whose removal results in the greatest reduction of dissimilarity in the residual set.

Dissimilarity function:

This function does not require a metric distance between the objects. It is any function that, if given a set of objects, returns a low value if the objects are similar to one another. The greater the dissimilarity among the objects, the higher the value returned by the function. The dissimilarity of a subset is incrementally computed based on the subset prior to it in the sequence. Given a subset of n numbers, $\{x_1, \dots, x_n\}$, a possible dissimilarity function is the variance of the numbers in the set, that is,

$$\frac{1}{n} \sum_{i=1}^n (x_i - \bar{x})^2,$$

where \bar{x} is the mean of the n numbers in the set. For character strings, the dissimilarity function may be in the form of a pattern string (e.g., containing wildcard characters that is used to cover all of the patterns seen so far. The dissimilarity increases when the pattern covering all of the strings in D_{j-1} does not cover any string in D_j that is not in D_{j-1} .

Cardinality function:

This is typically the count of the number of objects in a given set.

Smoothing factor:

This function is computed for each subset in the sequence. It assesses how much the dissimilarity can be reduced by removing the subset from the original set of objects.